

FREE!

FOX



2018



PRODUCT GUIDE

PACKED WITH
OUR LATEST AND
GREATEST PRODUCTS!



WELCOME

We know we say this every year, but we cannot believe how fast time flies! It seems like only yesterday that we were putting the finishing touches to our 2017 catalogue and now here we are welcoming you all to the start of our 2018 offering.

Here at Fox we care very much about our customers and we take great pride in being able to help carp anglers across the globe catch more carp year on year. Our tackle is designed by carp anglers for carp anglers, and what's more it is tested by some of the greatest carp anglers on the planet, so you can be safe in the knowledge that the hundreds of products that are awaiting you over the coming pages will be more than up to the job.

Once again our product development team have outdone themselves proud with a whole host of exciting new tackle items that we are sure you are going to love when you see them! So, what new products can you expect? Well, we have a brand new top-end luggage range, new brollies, bivvies, bedchairs, chairs, Edges end tackle, sleeping bags, clothing, rods, Black Label bite indicators and the one new product we are more excited about than any other: the awesome new RX+ bite alarm! So, without further ado please turn over the page and enjoy the full Fox 2018 range...

CONTENTS

Bite Indication	04-17	
Rods	18-25	
Reels & Line	26-35	
Shelters	36-61	
Bedchairs, Chairs & Sleeping Bags	62-73	
Luggage & Barrows	74-105	
Boats & Engines	106-111	
Rod Support	112-125	
Carp Care	126-133	
Tackle & Rig Storage	134-139	
Accessories	140-169	
Clothing	170-187	



BITE INDICATION

Within this section we will cover all things related to bite indication, so that means all of our Micron bite alarms, plus the actual bite indicators themselves including our legendary range of Swingers along with a comprehensive Black Label offering.

Starting with the bite alarms, we are very excited to be showcasing a brand-new offering in this catalogue: the RX+. It is the result of many years' hard work from our dedicated team of product designers and angling consultants and it replaces the NTXr, which has become somewhat of a legend in its own right. So you may be asking why we have replaced the NTXr? Well, turn the page and you'll see for yourselves; the bar has been well and truly raised by what is without any shadow of doubt the greatest bite alarm Fox have ever produced! In addition to the new RX+ you'll also find other offerings from the M-Series, which offers anglers Fox quality bite alarms at lower prices than our top-end option.

The RX+ bite alarm isn't the only new product that we are very excited to be sharing with you over the coming pages. We also have a host of new Black Label bite indicator products that are not only designed to make your set-up look very nice, but also more importantly aid bite indication to ensure you convert the most chances possible.

BITE INDICATION

RX+[®]



On/off toggle switch with two operational modes (day and night)



Indexed ergonomic controls for volume, tone and sensitivity - eight levels for each



Presentation Sets available

SENSITIVITY CONTROL

In all sensitivity settings (except maximum), the line must travel the specified distance in the same direction and within two seconds in order to trigger the unit. Any movement in the opposite direction will reset the distance counter to zero. This can substantially reduce, or eliminate false triggering caused by wind and water movement.

	Line Movement RX+	Line Movement NTX-R
Setting 1 (Min)	90mm	74mm
Setting 2	73mm	56mm
Setting 3	56mm	48mm
Setting 4	34mm	40mm
Setting 5	17mm	32mm
Setting 6	11mm	24mm
Setting 7	5.6mm	16mm
Setting 8 (Max)	2.8mm	8mm

NEW

MICRON[®] RX+[®]

- Weatherproof sealed case
- Digital circuitry
- D-Tec™ Plus Sensing System (DTSS)
- Low battery drain
- CNC machined Tru-Run™ roller wheel
- Twin multi-colour LEDs (Red, Green, Blue, Orange, Purple & White)
- On / Off toggle switch with 2 operational modes (day and night mode)
- When in night mode both LEDs will subtly glow in your chosen colour
- High quality cone speaker
- Rigid 3/8" stainless steel thread
- Rod-friendly rubber inlays
- Indexed ergonomic control for volume (8 different levels of volume with lowest setting being completely silent)
- Indexed ergonomic control for tone (eight different tone settings: turn dial clockwise to raise pitch and anti-clockwise to lower pitch)
- Indexed ergonomic control for Intelligent Sensitivity featuring See-Saw elimination (eight different sensitivity settings – see below Sensitivity table for comparison to NTX-R)
- Range test function allows user to check RX+ Receiver is picking up RX+ head at any given range
- Low battery warning (LED colour changes to cyan indicating it is time to replace batteries)
- Power Out Socket (2.5mm) for use with illuminated Swingers
- Supplied with two compression washer options: rigid and soft with an additional spare soft washer per unit
- Requires 2 x AA batteries

		*RRP
CEI159	Micron RX+	£169.99
CEI156	Micron RX+ 2 Rod Set	£449.99
CEI157	Micron RX+ 3 Rod Set	£599.99
CEI158	Micron RX+ 4 Rod Set	£749.99

IMPROVED FEATURES COMPARED TO NTX-R

- Deeper ears with no increase in the height of the alarm
- Twin multi-colour LEDs, one per ear and at the very top of the ear
- External control of the multi-colour LEDs with Colour Sync™ function – simply change LED colour via button on the battery cover
- Manually selectable day and night modes
- Larger clearance around the roller wheel and improved drainage vastly reduces chances of roller wheel freezing up in extreme cold conditions
- External control of the Vari-Bright adjustable LED brightness to suit the conditions you are fishing in (choice of three LED brightness settings in day mode and three different brightness settings in night mode) simply adjust via button on battery cover
- Stronger range performance with RX+ Receiver
- Improved sensitivity range (see below)

RX+[®] ALARM FEATURES

Twin multi-colour LEDs with Colour Sync

Rod-friendly rubber inlays

Digital circuitry

Volume

On/Off toggle switch

Tone

Sensitivity

High quality cone speaker

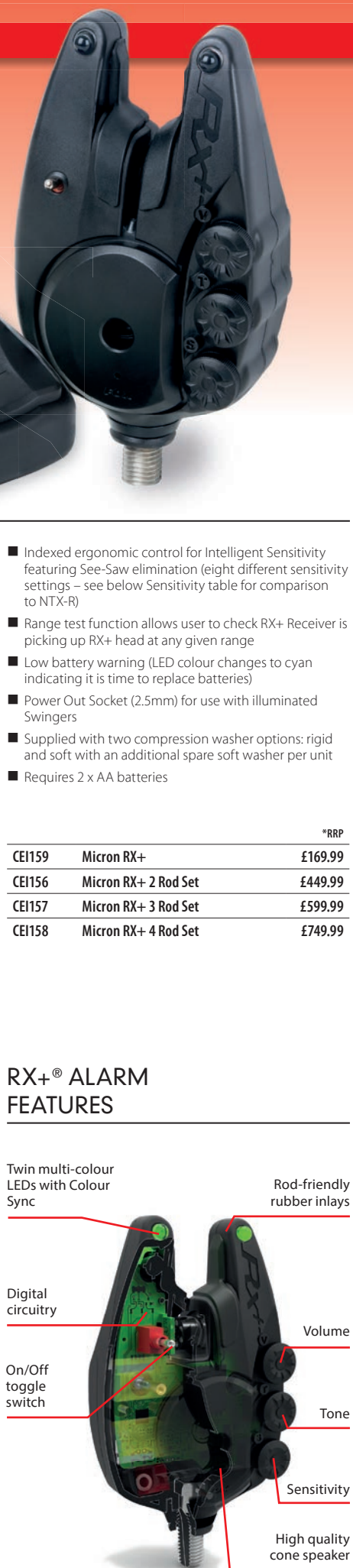



NEW

MICRON® RX+® RECEIVER

- Ultra-Long Range™
- Digital circuitry
- Low battery drain
- Battery life indication when receiver is switched on (4 x green LEDs indicates full/close to full, 3 x green LEDs indicates the batteries are used, but do not need replacing, 2 x orange LEDs indicates the batteries are becoming low, 1 x red LED indicates batteries are low and need replacing)
- Low battery warning (LEDs will flash cyan periodically indicating the batteries need replacing)
- Alarm low battery warning (when RX+ head turns to low battery warning so will the receiver for that particular alarm, again changing colour to cyan)
- Vibration alert function (via switch on rear)
- Bivvy light function (via switch on rear, see below for more details)
- Anti-theft alarm
- Easy RX+ Micron registration (via switch at rear)
- Indicator LEDs with Colour Sync™
- On/Off & volume control
- High quality cone speaker
- Lanyard attachment point
- Requires 3 x AA batteries

CEI160 Micron RX+ Receiver

*RRP

£169.99



Vibrate and Bivvy Light function switches located on rear of receiver



Easy RX+ Micron registration - up to 8 heads can work with 1 receiver



High quality cone speaker - can be set to total silence should you wish

IMPROVED FEATURES OVER NTX-R RECEIVER

- Larger indicator LED windows, visible from both the front and the top of the receiver
- Optional bivvy light function when you receive a bite
- Free standing design for placing on bivvy table/bucket lid
- Soft grip casing
- Ability to sync up to eight RX+ Micron heads
- Stronger radio performance
- Silent ON mode, full receiver function but with no sound output

BIVVY LIGHT FUNCTION

When the bivvy light feature is turned on via the switch on the back of the receiver it will behave in the following ways:

- The indication lights on the receiver will be dimmed slightly to prevent the receiver emitting too much light whilst the bivvy light is active
- The bivvy light will only come on if three bite triggers are received in quick succession to prevent liners and false indication turning your bivvy light on unnecessarily
- The bivvy light will fade into full brightness and remain on whilst the alarm continues to send trigger signals to the receiver. The light will fade out to nothing in the 5 seconds after the trigger lights have gone out on the receiver as long as no more indications are received



BITE INDICATION



MICRON® MXr+ RECEIVER

- Built-in I-Com Transmitter Technology
- Range independently tested to over 200m
- 4 x 5mm blue LEDs on all blue set
- Red, orange and green LEDs on 3-rod multi colour set
- Red, orange, green and blue LEDs on 4-rod multi colour set
- Self-standing design
- Adjustable volume
- Powered by 3 x AA batteries
- Low battery drain
- Lanyard supplied

*RRP

CEI152 Micron MXr+ Receiver £94.99



Presentation Sets available



MICRON® MXr+ PRESENTATION SETS

- Based on original MX+ alarm
- Built-in I-Com Transmitter Technology
- 5mm blue, red, green and orange LEDs available
- Two stage sensitivity
- Tru-Run roller wheel for super slick bite detection
- Cone speaker for enhanced sound quality
- Indexed tone adjustment knob
- Indexed volume adjustment knob
- Power out socket (for use with illuminated Swingers)
- Rubber ear inlays
- D-Tec Sensing System (DTSS) eliminates the need for the reed switches used in other alarms making it much more durable
- Powered by 2 x AAA batteries
- Low battery drain
- Hardcases supplied
- All blue presentation sets available in 2-rod, 3-rod and 4-rod
- Red, orange and green 3-rod presentation set available
- Red, orange, green and blue 4-rod presentation set available
- Single heads also available separately

*RRP

CEI141	Micron MXr+ 2-Rod Presentation Set	£299.99
CEI142	Micron MXr+ 3-Rod Presentation Set	£399.99
CEI143	Micron MXr+ 4-Rod Presentation Set	£475.00
CEI144	Micron MXr+ Single Head Blue LED	£94.99
CEI149	Micron MXr+ Red LED	£94.99
CEI150	Micron MXr+ Orange LED	£94.99
CEI151	Micron MXr+ Green LED	£94.99
CEI153	Micron MXr+ 3 Rod Multi Colour Set	£399.99
CEI154	Micron MXr+ 4 Rod Multi Colour Set	£499.99



MICRON® Mr+ PRESENTATION SETS

- Based on original M+ alarm
- Built-in I-Com Transmitter Technology
- 5mm red LED
- Indexed volume adjustment knob
- Tru-Run roller wheel for super slick bite detection
- Power out socket (for use with Illuminated Swingers)
- Piezo speaker for clear sound
- Rubber ear inlays
- Micro Transmitter
- D-Tec Sensing System (DTSS) eliminates the need for the reed switches used in other alarms making it much more durable
- Powered by 2 x AAA batteries
- Low battery drain
- Hardcases supplied
- Available in 2-rod, 3-rod and 4-rod presentation sets
- Single heads also available separately

*RRP

CEI137	Micron Mr+ 2-Rod Presentation Set	£199.99
CEI138	Micron Mr+ 3-Rod Presentation Set	£249.99
CEI139	Micron Mr+ 4-Rod Presentation Set	£325.00
CEI140	Micron Mr+ Single Head	£74.99





MICRON® MX+

- 5mm blue LED
- Two stage sensitivity
- Cone speaker for enhanced sound quality
- Indexed tone adjustment knob
- Indexed volume adjustment knob
- 1 x power out socket (for use with illuminated Swingers)
- 1 x transmitter out socket
- Rubber ear inlays
- D-Tec Sensing System (DTSS) eliminates the need for the reed switches used in other alarms making it much more durable
- Powered by 2 x AAA batteries
- Long battery life
- Free hardcase supplied

MICRON® M+

- 5mm red LED
- Indexed volume adjustment knob
- 1 x power out socket
- 1 x transmitter out socket
- Piezo speaker for clear sound
- Rubber ear inlays
- Micro transmitter
- D-Tec Sensing System (DTSS) eliminates the need for the reed switches used in other alarms making it much more durable
- Powered by 2 x AAA batteries
- Free hardcase supplied



Our sensors guarantee instant bite detection and rubber inlays in the 'ears' eliminate rod slippage



Two accessory outputs: one a power out for use with illuminated indicators, the other a transmitter output for use with the TX-R Micro



Classic Micron styling with an easy-to-use front toggle on/off switch and hi-visibility raised 5mm LEDs

CEI120 Micron MX+ *RRP £49.99

CEI119 Micron M+ *RRP £34.99

ALARM COMPARISON CHART	MICRON® RXr+®	MICRON® MXr+	MICRON® Mr+	MICRON® MX+	MICRON® M+
Built in Radio	✓	✓	✓	-	✓
Volume Control	✓	✓	✓	✓	✓
Tone Control	✓	✓	-	✓	-
Intelligent™ Sensitivity (number of positions)	✓	✓ 2	-	✓ 2	-
D-Tec™ Sensing System (DTSS)	✓	✓	✓	✓	✓
LED Colours (M=Multi-colour, B=Blue, R=Red)	M	M	R	B	R
Night Mode	✓	-	-	-	-
Drop Back Differentiation	✓	-	-	-	-
Power Out Socket	✓	✓	✓	✓	✓
Extension Box Socket	-	-	-	✓	✓
Low Level Battery Warning	✓	✓	✓	✓	-
Battery	2x AA	2x AAA	2x AAA	2x AAA	2x AAA
Receiver/Transmitter Rating					
Cone Speaker	✓	✓	-	✓	-
Piezo Speaker	-	-	✓	-	✓
Easy Micron Registration	✓	-	-	-	-
Colour Sync	✓	-	-	-	-
Anti-Theft Alarm	✓	-	-	-	-
*RRP	£169.99	£94.99	£74.99	£49.99	£34.99



Black Label bite indicators were designed to complement our market-leading Black Label bankware range and really do mix style with functionality.

One of the main benefits of the Black Label range is that you can purchase a set of bobbins for a relatively low price and then customise them to suit the angling situation you are faced with by utilising our Custom Indicator System (C.I.S).



SLIK® BOBBIN

- Comes supplied with black Hockey Stick, 3ins Black Ball Chain, Slim Head and a Slik Clip
- Features our unique Slik bobbin clip which 'fixes' to your mainline for far greater bite indication
- Slik Clip ensures bobbin moves as soon as there is any line movement
- Ideal for use at short-medium range
- Perfect for slack and semi-slack lines
- Line pulls free of clip section on bite then becomes free running through middle recess
- Can easily be converted using Black Label C.I.S

		*RRP
CBI052	Black Label Bobbin White	£11.99
CBI053	Black Label Bobbin Blue	£11.99
CBI054	Black Label Bobbin Red	£11.99
CBI055	Black Label Bobbin Purple	£11.99
CBI056	Black Label Bobbin Green	£11.99
CBI057	Black Label Bobbin Gunsmoke	£11.99
CBI083	Black Label Bobbin Orange	£11.99



NEW

STEALTH BOBBIN

- Machined aluminium body
- Memory-free 6in super soft black Dacron cord with machined black aluminium hockey stick connection
- Cord can be shortened should you wish
- Narrow mid-section with isotope viewing slots allows glow from isotope to be seen from all angles
- Ideal for slack line fishing at short range and semi-slack line fishing at medium range
- Features unique Black Label Slik Bobbin Clip, which can fix to line for greater sensitivity but can also be left free running should you wish
- Line tension can be adjusted by tightening or loosening clip on the body
- Weighs 5g

- Colours can be changed at any time by purchasing individual Slik Bobbin Clips and removing the black collar they are supplied with

		*RRP
CBI088	Stealth Bobbin Red	£12.99
CBI089	Stealth Bobbin Orange	£12.99
CBI090	Stealth Bobbin Green	£12.99
CBI091	Stealth Bobbin Blue	£12.99
CBI092	Stealth Bobbin Purple	£12.99
CBI093	Stealth Bobbin White	£12.99
CBI094	Stealth Bobbin Black	£12.99



NEW

DUMPY BOBBIN

- Classic old school look
- Injection moulded opaque coloured main body with two transparent isotope windows
- Isotope windows allow you view glow from the sides or from the front
- Unique indented cap is removable allowing the isotopes to be inserted and also allows the you to perfectly align the line clip and isotope windows
- Weighs 13g
- Supplied with brass weight insert that can be added to the body to bring total weight to 20g
- Available in Red, Orange, Green, Blue, Purple, White and Black
- 6ins black anodised ball chain

- Machined black aluminium hockey stick connection
- Ideal for medium to long range

		*RRP
CBI097	Dumpy Bobbin Red	£14.99
CBI098	Dumpy Bobbin Orange	£14.99
CBI099	Dumpy Bobbin Green	£14.99
CBI100	Dumpy Bobbin Blue	£14.99
CBI101	Dumpy Bobbin Purple	£14.99
CBI102	Dumpy Bobbin White	£14.99
CBI103	Dumpy Bobbin Black	£14.99



SLIK® BOBBIN CLIPS

- Can be used to convert a standard Black Label Bobbin into a Slik Bobbin for greater sensitivity
- Adjustable collar to change tightness of clip for differing line diameters
- Also enables you to customise your Slik Bobbins with different colour heads
- Available in Green, Red, White, Blue, Black, Purple and Orange

		*RRP
CBI058	Black Label Bobbin Clip White	£3.75
CBI059	Black Label Bobbin Clip Blue	£3.75
CBI060	Black Label Bobbin Clip Red	£3.75
CBI061	Black Label Bobbin Clip Purple	£3.75
CBI062	Black Label Bobbin Clip Green	£3.75
CBI063	Black Label Bobbin Clip Black	£3.75
CBI084	Black Label Bobbin Clip Orange	£3.75



MICRO HEAD

- Very sexy, miniature bobbin head
- Measure just 16mm long
- Perfect for fishing slack lines at short range
- Allows you to convert standard and Slik Bobbins into much smaller, lighter bobbin in seconds
- Available in Green, Red, White, Blue, Gunsmoke, Purple and Orange

		*RRP
CBI046	Black Label Micro Head White	£3.75
CBI047	Black Label Micro Head Blue	£3.75
CBI048	Black Label Micro Head Red	£3.75
CBI049	Black Label Micro Head Purple	£3.75
CBI050	Black Label Micro Head Green	£3.75
CBI051	Black Label Micro Head Gunsmoke	£3.75
CBI082	Black Label Micro Head Orange	£3.75

NEW

COLOURED BALL CLIPS

- Opaque ball clips available in seven colours: Red, Orange, Green, Blue, Purple, White and Black
- Adjustable tension collar
- Allows you to match your bobbin clip to the bobbin body and the bite alarm LED
- Can be used with all Black Label Bobbins (except the Stealth models)

		*RRP
CBI111	Coloured Ball Clip Red	£4.49
CBI112	Coloured Ball Clip Orange	£4.49
CBI113	Coloured Ball Clip Green	£4.49
CBI114	Coloured Ball Clip Blue	£4.49
CBI115	Coloured Ball Clip Purple	£4.49
CBI116	Coloured Ball Clip White	£4.49
CBI117	Coloured Ball Clip Black	£4.49



NEW

COLOURED PIVOTING BALL CLIPS

- Opaque pivoting clips available in seven colours: Red, Orange, Green, Blue, Purple, White and Black
- Allows you to match your bobbin clip to the bobbin body and the bite alarm LED
- Can be used with all Black Label Bobbins (except the Stealth models)

		*RRP
CBI104	Pivoting Ball Clip Red	£5.99
CBI105	Pivoting Ball Clip Orange	£5.99
CBI106	Pivoting Ball Clip Green	£5.99
CBI107	Pivoting Ball Clip Blue	£5.99
CBI108	Pivoting Ball Clip Purple	£5.99
CBI109	Pivoting Ball Clip White	£5.99
CBI110	Pivoting Ball Clip Black	£5.99





POWER GRIP LINE CLIPS

- CAD-designed line clips that hold line securely without causing any damage
- Line sits in small recess behind arm of clip so it is not damaged
- Rubber inlay prevents clip from damaging rod blank
- Available in two colours – White and Orange
- Available in two sizes – Small and Large
- Three clips per packet

		*RRP
CAC594	Line Clips Small x3 White	£7.99
CAC595	Line Clips Small x3 Orange	£7.99
CAC596	Line Clips Large x3 White	£7.99
CAC597	Line Clips Large x3 Orange	£7.99



NEW

TITANIUM QUIVER ARMS

- Titanium wire quivers for ultimate bite indication
- Compatible with all Slim Black Label heads
- Recommended for use with Micro Heads with either a Pivoting Ball Clip or standard Coloured Ball Clip
- 3 diameters available to suit the range you fish at: Super Soft for short/medium range, Medium for medium/long range and Stiff for long/extreme range
- Super Soft enables you to fish with semi-slack lines
- Can be used in conjunction with the Black Label Adjustable Hockey Stick to create the optimum tension for most fishing situations

		*RRP
CBI085	Titanium Quivers Soft	£5.99
CBI086	Titanium Quivers Medium	£5.99
CBI087	Titanium Quivers Stiff	£5.99



NEW

STEALTH CORD

- Memory-free 6ins super soft and lightweight black Dacron cord
- Can be cut down to a shorter length should you require
- Perfect for slack line fishing at short range and semi-slack fishing at medium range

		*RRP
CBI096	6" Stealth Cord	£4.99



NEW

CHAIN LINK

- 6ins black anodised link chain
- Complements Black Label bankware range
- Ideal for short to medium range fishing

		*RRP
CBI095	6" Chain Link	£4.99

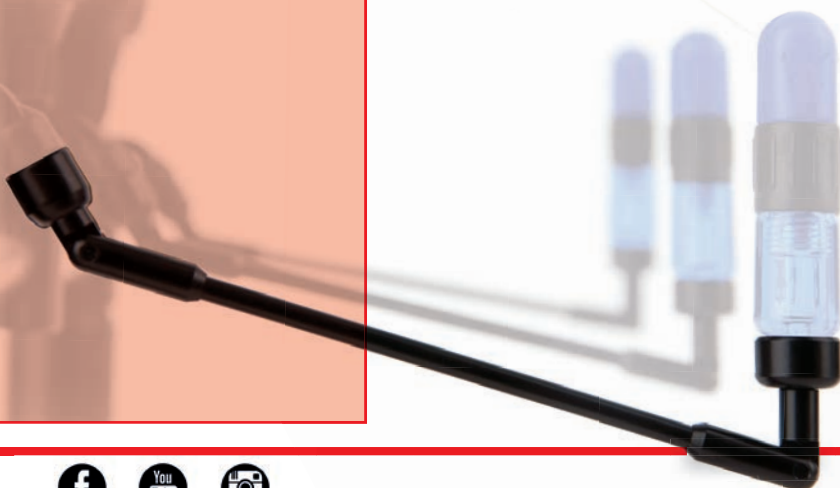

MINI SWINGER® ARM

- Based on traditional Swinger design
- Pivot points at both ends for extra sensitivity
- Black, anodised finish
- Ideal for windy conditions
- Complements Black Label bankware range

		*RRP
CBI066	Black Label Mini Swinger Arm	£6.99



NEW

ADJUSTABLE ROD CLIPS

- Designed for fishing bow-string tight lines with quiver style indicators
- Adjustable tensioning dial to accommodate low diameter monofilament and braid
- Can also be used with light bobbins when fishing slacker lines for increased bite indication
- One size to fit all rods (ensure rod blank is clean before attaching)
- Increases the angle in the line to give improved visual indication
- Interchangeable black ball clips (allows you to customise with new coloured Black Label Ball Clips should you wish)

CBI124 Adjustable Rod Clips x2 *RRP
£7.99



SLIM WEIGHTS

- Allows you to increase weight of slim heads supplied on Bobbin and Slik Bobbin
- Weigh 5g each
- Two weights supplied per packet
- Hardwearing, black anodised finish
- Complements Black Label bankware range

CBI064 Slim Weights 5g x 2 *RRP
£3.75



ISOTOPES

- Enables your bobbin head to have a subtle glow in the dark
- Available in two sizes – Standard (3mm x 25mm) and Micro (2mm x 12mm)
- Only available to buy in United Kingdom

		*RRP
CLI006	Isotope Standard	£12.99
CLI007	Isotope Micro	£7.99



HOCKEY STICK

- Constructed from hardwearing injection moulded black plastic
- Can be used with Black Label Springer Arm, Swinger Arm, Dacron Cord, Ball Chain or Link Chain
- Easy to use screw thread

CBI072 Black Label Hockey Stick x 1 *RRP
£3.75



NEW

ADJUSTABLE HOCKEY STICKS

- Injection moulded hard-wearing black plastic
- Adjustable stick allows you to set the tension you require from your bite indicator – simply screw your chosen cord, chain or quiver arm into place to lock the hockey stick in position

CBI118 Adjustable Hockey Stick *RRP
£4.99

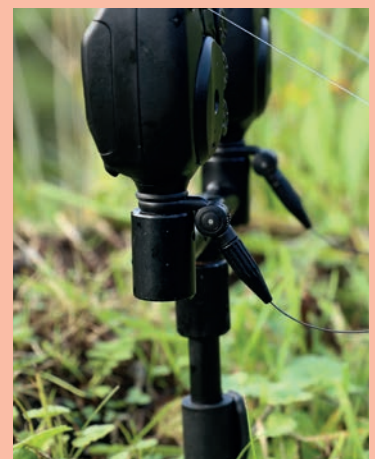

The Adjustable Hockey Stick allows you to change the tension of your indicator



MK2 ILLUMINATED SWINGER®

- Matt black anodised coating on arm and weight
- Illuminates when connected to bite alarm with power out facility
- Head display mimics Micron LED to signal drop back indication
- Streamlined Micron attachment tabs
- Rubber shock absorbers on bottom of head
- Widened front end for increased visibility
- Spring loaded adjustable tensioning system
- Fixed line gate system
- 80g sliding collar weight
- Light reactive acrylic indicator head
- Betalight Slot
- Available in Red, Orange, Green, Blue, Black and new Purple colour options
- 3-Rod presentation set available (Red, Orange and Green)
- 4-Rod presentation set available (Red, Orange, Green and Blue)
- Swinger Case also available separately

		*RRP
CS1049	MK2 Illuminated Swinger Red	£39.99
CS1050	MK2 Illuminated Swinger Orange	£39.99
CS1051	MK2 Illuminated Swinger Green	£39.99
CS1052	MK2 Illuminated Swinger Blue	£39.99
CS1053	MK2 Illuminated Swinger Black	£39.99
CS1063	MK2 Illuminated Swinger Purple	£39.99
CS1054	MK2 Illuminated Swinger 3-Rod Set (R,O,G)	£119.99
CS1055	MK2 Illuminated Swinger 4-Rod Set (R,O,G,B)	£155.99
CS1058	MK2 Illuminated Swinger Case	£15.99



Available in 3-rod and 4-rod presentation sets



MK3 SWINGER®

- Matt black anodised coating on arm and weight
- Streamlined Micron attachment tabs
- Fixed line gate system
- Rubber shock absorbers on bottom of head
- Widened front end for increased visibility
- Light reactive acrylic indicator head
- Betalight slot
- 50g Sliding weight allows tension on line to be adjusted
- Available in Red, Orange, Green, Blue, Black and new Purple colour options
- 3-Rod presentation set available (Red, Orange and Green)
- 4-Rod presentation set available (Red, Orange, Green and Blue)
- Swinger Case also available separately

		*RRP
CSI042	MK3 Swinger Red	£22.99
CSI043	MK3 Swinger Orange	£22.99
CSI044	MK3 Swinger Green	£22.99
CSI045	MK3 Swinger Blue	£22.99
CSI046	MK3 Swinger Black	£22.99
CSI062	MK3 Swinger Purple	£22.99
CSI047	MK3 Swinger 3-Rod Set (R,O,G)	£79.99
CSI048	MK3 Swinger 4-Rod Set (R,O,G,B)	£99.99
CSI057	MK3 Swinger Case	£15.99



Available in 3-rod and 4-rod presentation sets

MICRO SWINGER®

- Matt black anodised coating on arm and weight
- Compact stainless steel arm for greater sensitivity at short and medium range
- Adjustable line clip system
- Low friction gate on head
- 42g sliding collar weight
- Light reactive acrylic indicator head
- Betalight slot
- Available in Red, Orange, Green, Blue, Black and new Purple colour options
- 3-Rod presentation set available (Red, Orange and Green)
- 4-Rod presentation set available (Red, Orange, Green and Blue)
- Swinger Case also available separately

		*RRP
CSI035	Micro Swinger Red	£14.99
CSI036	Micro Swinger Orange	£14.99
CSI037	Micro Swinger Green	£14.99
CSI038	Micro Swinger Blue	£14.99
CSI039	Micro Swinger Black	£14.99
CSI061	Micro Swinger Purple	£14.99
CSI040	Micro Swinger 3-Rod Set (R,O,G)	£49.99
CSI041	Micro Swinger 4-Rod Set (R,O,G,B)	£64.99
CSI056	Micro Swinger Case	£15.99



Available in 3-rod and 4-rod presentation sets







RODS

In last year's catalogue we were delighted to launch our lowest ever priced entry level carp rods in the shape of the EOS range. This range gave anglers access to Fox quality at value for money prices never previously thought possible. Following on from such a successful launch our product team wanted to push the bar at the top end of the market. For the past few years rods like the Horizon XT and XTK have set the standard for top quality casting rods at far more competitive prices than custom built models that were on the market at the time. Not wanting to rest on their laurels our team of product experts believed the Bar could be raised further still and they were not wrong as the end result of countless hours research, development and testing is our brand-new Horizon X5 rod range that replaces both the XT and XTK and that you will find when you turn over the page.

This means we now have five ranges of rod in our portfolio, designed to mean that whatever your budget, fishing style or venue you are targeting, you're sure to find a Fox rod that perfectly suits you. All of our rods are designed and tested by carp anglers and utilise the latest cutting edge rod construction technology and materials to ensure that when you purchase a Fox rod you are investing in the best...



Laser-etched Fox head logo in butt cap on all rods in the Horizon X5 range



All models benefit from market-leading Fuji 18mm DPS real seats



Fuji K-Series guides throughout - 50mm butt ring through to 16mm tip



Skinny Duplon or Abbreviated handle option for fishing rods. Spod/Marker features full Japanese shrink wrap



All rods feature a 50mm K-Series butt ring that reduces tangles from occurring on the cast

NEW

HORIZON® X5

- Ultra high modulus carbon blank featuring Multidirectional Nanofibre and Interlaminar resin
- Blank also features 1k carbon wrap
- Fast recovery to aid distance and accuracy when making the biggest of casts
- Superb playing action
- Reinforced carbon power joints for added strength at spigot
- Fuji K-Series Guides throughout - 50mm butt to 16mm tip – these dramatically help to prevent tangles from occurring on the cast
- Fuji 18mm DPS reel seat
- Black fittings and whippings
- Understated cosmetics

		*RRP
CRD259	Horizon X5 12ft 3.25lb Abbreviated	£289.99
CRD261	Horizon X5 12ft 6in 3.5lb Abbreviated	£299.99
CRD263	Horizon X5 12ft 3.75lb Abbreviated	£299.99
CRD265	Horizon X5 13ft 3.75lb Abbreviated	£319.99
CRD260	Horizon X5 12ft 3.25lb Full Slim Duplon	£299.99
CRD262	Horizon X5 12ft 6in 3.5lb Full Slim Duplon	£309.99
CRD264	Horizon X5 12ft 3.75lb Full Slim Duplon	£309.99
CRD266	Horizon X5 13ft 3.75lb Full Slim Duplon	£329.99

NEW

HORIZON® X5 SPOD/MARKER

- Styled to match the Horizon X5 fishing rods
- 5.5lb test curve
- Multi-purpose rod for both feature finding and baiting up with heavy spods
- Fuji K-Series Guides throughout - 50mm butt to 16mm tip – these dramatically help to prevent tangles from occurring on the cast
- Benefits from many of the same features as the fishing rods
- 12ft and 13ft options available

		*RRP
CRD267	X5 12ft Spod/Marker Japanese Shrink Wrap	£239.99
CRD268	X5 13ft Spod/Marker Japanese Shrink Wrap	£249.99



2018





Fox Slik Anti Tangle butt guide



Black 18mm Fuji DPS reel seat



16mm Slik Anti Tangle tip guide



Various handle options

HORIZON® X

- 10 models available
- Range caters for distance casting, medium range, margin fishing and boat anglers
- Fox Slik Anti Tangle black guides throughout
- Black Fuji 18mm DPS reel seat
- 2k diagonal wrap on butt and 1k on tip makes them very lightweight yet incredibly strong
- The blanks are lighter and stronger than original Horizon
- All models (except the 10ft models and the 2.75lb models) feature a 50mm butt ring as standard
- 10ft models ideal for small waters, and rowing and bait boat users
- Abbreviated, Skinny Duplon and Skinny Cork handle options available

		*RRP
CRD228	Horizon X 10ft 3lb Abbreviated	£199.99
CRD229	Horizon X 10ft 3.5lb Abbreviated	£204.99
CRD220	Horizon X 12ft 2.75lb Abbreviated	£204.99
CRD221	Horizon X 12ft 3lb Abbreviated	£214.99
CRD224	Horizon X 12ft 3.5lb Abbreviated	£224.99
CRD227	Horizon X 13ft 3.5lb Abbreviated	£234.99
CRD223	Horizon X 12ft 3lb Duplon	£224.99
CRD226	Horizon X 12ft 3.5lb Duplon	£234.99
CRD222	Horizon X 12ft 3lb Cork	£224.99
CRD225	Horizon X 12ft 3.5lb Cork	£234.99



TORQUE®

- Designed to fill the gap between the Warrior S and Horizon X ranges
- High quality carbon blank that is amongst the lightest and strongest ever produced at this price point
- Black 18mm Fuji DPS reel seat
- Black Fox Slik Guides throughout
- 50mm butt ring on all models apart from 10ft 3lb and 12ft 2.75lb
- 10ft models ideal for small waters, and rowing and bait boat users
- Abbreviated and Skinny Duplon handle options available
- Understated graphic to give a 'custom built' feel
- Matching spod and marker also available
- Matching landing nets available see page 133

TORQUE® SPOD

- Styled to match the Torque fishing rods
- 5.5lb test curve enables you to cast fully loaded Impact Spods to the horizon
- Same top quality carbon blank as the fishing rods and features 50mm butt ring
- Benefits from many of the same features as the fishing rods

TORQUE® MARKER

- Stiff tip aids sensitivity when feeling features on the lakebed
- Styled to match the Torque fishing rods
- 4.5lb test curve enables you to cast a marker float similar distance to your rigs and spod
- Same top quality carbon blank as the fishing rods and features a 50mm butt ring

		*RRP
CRD251	Torque 10ft 3lb Abbreviated	£124.99
CRD211	Torque 12ft 3lb Abbreviated	£139.99
CRD213	Torque 12ft 3.5lb Abbreviated	£139.99
CRD215	Torque 13ft 3.5lb Abbreviated	£149.99
CRD216	Torque 12ft 4.5lb Marker Abbreviated	£139.99
CRD217	Torque 12ft 5.5lb Spod Abbreviated	£139.99
CRD212	Torque 12ft 3lb Duplon	£149.99
CRD214	Torque 12ft 3.5lb Duplon	£149.99



Two handle options available



Black 18mm Fuji DPS reel seat



16mm black Fox Slik tip guide



50mm butt on all models except 10ft 3lb and 12ft 2.75lb



18mm DPS-style reel seat



3-Piece 12ft 3lb model also available



Full cork versions also available in selected test curves

WARRIOR® S

- Legendary rod series that has won multiple awards across Europe
- Fox Slik guides (40mm butt to 14mm tip, 50mm butt on S50 models)
- DPS-style 18mm reel seat with reinforced steel collar
- Matt black, understated finish
- 10ft models ideal for small waters, and rowing and bait boat users
- Full Cork available in 2.75lb and 3lb test curves
- Line-friendly CAD-engineered line clip
- Laser engraved gunsmoke butt cap
- Three piece, 12ft 3lb Warrior S also available
- S50 models available in 12ft 3lb and 12ft 3.5lb
- Matching landing nets available see page 133

WARRIOR® S SPOD

- DPS-style reel seat
- Fox Slik Guides
- Outstanding value for money
- 5.5lb test curve
- Complements other rods in Warrior S range

WARRIOR® S MARKER

- DPS-style reel seat and Fox Slik guides
- Whipped markings at 6ins (15cm) and 12ins (30cm) for easy depth location
- Stiff 3lb test curve allowing for long casts and also transmitting the topography of the lakebed

		*RRP
CRD199	Warrior S 10ft 3lb	£69.99
CRD200	Warrior S 10ft 3.5lb	£74.99
CRD137	Warrior S 12ft 2.75lb	£74.99
CRD138	Warrior S 12ft 2.75lb Full Cork	£84.99
CRD139	Warrior S 12ft 3lb	£74.99
CRD163	Warrior S 12ft 3lb Full Cork	£84.99
CRD140	Warrior S 12ft 3.5lb	£79.99
CRD202	Warrior S 12ft 3lb 3-Piece	£74.99
CRD252	Warrior S50 12ft 3.5lb 50mm butt	£84.99
CRD207	Warrior S50 12ft 3lb 50mm butt	£79.99
CRD141	Warrior S 12ft 5.5lb Spod	£79.99
CRD142	Warrior S 12ft 3lb Marker	£79.99



EOS®

- Designed to offer incredible value for money
- Five models available including new 10ft 3lb and 12ft 3lb 3-Piece
- Perfect newcomers, juniors or anglers on a very tight budget that still want Fox quality
- Lightweight low resin, high quality carbon construction
- Understated matt black finish
- Ergonomic tapered butt grip
- 18mm DPS-style reel seats hold reels of all sizes securely
- Tried and trusted Fox SLIK guide system
- 10ft and 12ft 3lb is perfect for smaller venues and use with bait and rowing boats
- 12ft 3lb 3-Piece is ideal for small vehicles and traveling light (comprises 3 x 4ft/122cm sections)
- 13ft 3.5lb ideal for larger venues where longer casts may be needed – also ideal for PVA bag and Method feeder fishing
- 12ft 3lb Telescopic model also available, which retracts to 4ft (122cm) for compact storage when in transit
- All models except 13ft feature 40mm butt ring through to 14mm tip ring
- 13ft 3.5lb features a larger 50mm butt ring through to 16mm tip ring to aid casting performance



18mm DPS-style reel seat



Top quality carbon blank



SLIK guide system throughout

			*RRP
CRD258	EOS 10ft 3lb Abbreviated	NEW	£39.99
CRD254	EOS 12ft 3lb Abbreviated		£44.99
CRD255	EOS 13ft 3.5lb Abbreviated		£54.99
CRD257	EOS 12ft 3lb Abbreviated - 3 pc	NEW	£44.99
CRD256	EOS 12ft 3lb Telescopic Abbreviated		£44.99



REELS & LINE



When purchasing reels for carp fishing you have a simple choice to make. Do you want to purchase reels designed for sea fishing that have been given a few cosmetic tweaks to appeal to a carp angler, or do you want to invest in a reel that has been designed and tested by carp anglers specifically for carp fishing? If your answer is the latter then the Fox reels you are about to see over the coming pages will be ideal for you. All of our reels are the result of countless hours' research and development by our team of expert product designers, alongside our top consultants from across Europe and have been designed for you. We are obviously biased but we truly believe that our range of reels offers value for money like no others you will find in a tackle shop and we are convinced that once you give them a try you will agree with that statement!

There are no changes to our reel line up for this 2018 catalogue, simply because the models in our range last year are so popular and of such great quality that we saw little point in changing things for the sake of it.

When investing in reels it is also important that you take time to consider what lines you will spool them up with. There is little point investing in reels of the quality that we offer only to then pair them up with sub-standard line that will let you down. Our range of main lines is comprehensive to say the least and you'll find all bases are covered whether you like monofilament, braid or fluorocarbon...



Machined solid aluminium handle



Super slow oscillation allows for immaculate line lay



Quick clutch with grit guard



Carbon-reinforced polymer body



FX13

- Bigger brother to our top-selling FX11
- Huge line capacity that is ideal for distance casting and long range boat fishing
- Machined solid aluminium handle
- Stainless steel shaft
- 90cm of line retrieved per handle turn
- Super-slow oscillation for immaculate line lay
- Carbon reinforced polymer body and rotor
- Quick clutch with grit guard
- Minimalist matt black styling and discreet silver trims
- Rotor brake
- Anti-backlash system
- Micro line lay adjustment
- Rotor line guard
- 2 range casting line clips – one black, one silver
- Rotor Balanced Profile
- Twist free roller
- Pro-cast lip on spool
- 5 stainless steel ball bearings + 1 roller bearing
- Gear ratio: 4.3:1
- Weight: 761g

		*RRP
CRL071	FX13 Reel	£139.99
CRL072	FX13 - Standard Spare Spool	£29.99
CRL073	FX13 - Spare Shallow Spool	£29.99

LINE CAPACITY

mm	m
0.33	750
0.35	650
0.37	570
0.40	500

Spare spools available separately





FX11

- New machined solid aluminium handle
- Improved gearing
- Super-slow oscillation for immaculate line lay
- 95cm of line retrieved per handle turn
- Quick Clutch with grit guard
- Hardwearing, graphite body, with minimalist matt black styling and discreet silver trims
- Rotor brake
- Anti-backlash system
- Micro line lay adjustment
- Rotor line guard
- 2 range casting line clips – one black, one silver
- Rotor Balanced Profile
- Twist free roller
- Pro-cast lip on spool
- 5 stainless steel ball bearings + 1 roller bearing
- Gear ratio: 4.6:1
- Weight: 590g

Spare spools available separately

		*RRP
CRL070	FX11 Reel	£119.99
CRL058	FX11 - Spare Spool	£29.99
CRL061	FX11 - Spare Shallow Spool	£29.99

LINE CAPACITY

mm	m
0.30	590
0.33	490
0.35	435
0.37	390



1.5 turn Quick Clutch for accurate adjustment from locked-up to Freespool



Outstanding 'slow oscillation' line lay and long spool for increased casting performance



New and improved machined solid aluminium handle



Lightweight compact body keeps weight to a minimum for increased rod speed when casting



Two sprung lines clips to protect your line when hitting the clip



New and improved machined solid aluminium handle



Quick clutch and super-slow oscillation for perfect line lay



Lightweight compact body keeps weight to a minimum



FX9

- New machined solid aluminium handle
- Improved gearing
- Super-slow oscillation for immaculate line lay
- 80cm of line retrieved per handle turn
- Quick clutch with grit guard
- Hardwearing, graphite body, with minimalist matt black styling and discreet silver trims
- Rotor brake
- Anti-backlash system
- Micro line lay adjustment
- Rotor line guard
- 2 range casting line clips – one black, one silver
- Rotor Balanced Profile
- Twist free roller
- Pro-cast lip on spool
- 5 stainless steel ball bearings + 1 roller bearing
- Gear ratio: 4.6:1
- Weight: 560g

		*RRP
CRL069	FX9 Reel	£109.99
CRL068	FX9 - Spare Spool Standard	£24.99

LINE CAPACITY

mm	m
0.30	330
0.33	310
0.35	280
0.37	220

Spare spools available separately





EOS 12000

- Matt black styling with understated graphics
- Hardwearing graphite body
- Suited to general fishing and also use as a spod reel
- Quick front clutch with grit guard
- Pro-cast lip on spool
- Twist Free roller
- Mesh-Tec gearing system
- Anti-Backlash system
- Rotor line guards
- Sprung line clip
- CNS system
- 7 stainless ball bearings + 1 roller bearing
- Spare spool options available separately
- Gear ration 4.5:1
- Weight 744g

		*RRP
CRL074	EOS 12000 Reel	£99.99
CRL076	EOS 12000 - Spare Spool Shallow	£24.99
CRL077	EOS 12000 - Spare Spool Standard	£24.99
CRL078	EOS 12000 - Spare Spool Deep	£24.99

LINE CAPACITY

mm	m
0.34	375
0.39	300
0.42	275

Spare spools available separately



Sprung line clip on spool

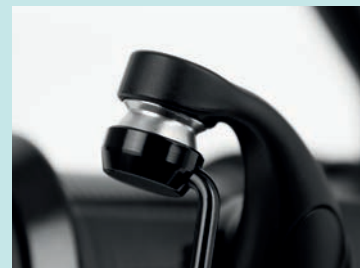

Twist Free Roller on bail arm



Quick clutch with grit guard



Hardwearing graphite body



Freespool facility at rear



Hardwearing graphite body



Ergonomic handle



Adjustable tension for Freespool



EOS 12000FS

- Matt black styling with understated graphics
- Freespool facility at rear allows you to go from locked up to running clutch with flick of switch
- Suited for general fishing and also use on a marker rod
- Hardwearing graphite body
- Quick front clutch with grit guard
- Pro-cast lip on spool
- Twist Free Roller
- Mesh-Tec gearing system
- Anti-Backlash system
- Rotor line guards
- Sprung line clip
- CNS system
- Stylish all black handle, spool and bail arm
- 10 stainless ball bearings + 1 roller bearing
- Spare spool options available separately
- Weight 843g
- Gear ratio: 4.2:1

Spare spools available separately

		*RRP
CRL075	EOS 12000FS	£129.99
CRL076	EOS 12000FS - Spare Spool Shallow	£24.99
CRL077	EOS 12000FS - Spare Spool Standard	£24.99
CRL078	EOS 12000FS - Spare Spool Deep	£24.99

LINE CAPACITY

mm	m
0.34	375
0.39	300
0.42	275





EOS 10000

- Ideal for smaller venues where casts under 90m are needed
- 5 stainless ball bearings
- Great line lay aids casting
- Smooth clutch
- Freespool facility at rear allows you to go from locked up to running clutch with flick of switch
- Weight 558g
- Rotor balanced profile
- Line-friendly line clip
- Gear ratio 5:5:1
- Large handle for cranking power
- Weight 558g

		*RRP
CRL059	EOS 10000	£59.99
CRL060	EOS 10000 - Spare Spool	£19.99

LINE CAPACITY

mm	m
0.34	375
0.39	300
0.42	275

Spare spools available separately



Anti-twist line roller



Easy to adjust, responsive front drag



Freespool facility with adjustable tension



Soft touch, ergonomic handle

EXOCET® MONO TRANS KHAKI

- Trans Khaki colour, which is almost invisible in water
- Number one choice for many of the UK and Europe's leading carp anglers
- Low diameter and supple making it perfect for long range casting
- Great abrasion resistance considering low diameter
- Sinks surprisingly well for such a supple line
- Great knot strength and low memory
- Supplied on 1000m bulk spools



	Breaking Strain	Diameter	Metres on Spool	*RRP
CML149	10lb/4.55kg	0.26mm	1000m	£21.99
CML150	13lb/5.90kg	0.30mm	1000m	£21.99
CML151	16lb/7.27kg	0.33mm	1000m	£21.99
CML152	18lb/8.18kg	0.35mm	1000m	£21.99
CML153	20lb/9.09kg	0.37mm	1000m	£21.99
CML154	23lb/10.45kg	0.40mm	1000m	£21.99

CAMO SOFT® STEEL

- Available in both Light and Dark Camo
- Low stretch and very strong
- Very supple, low diameter making it perfect casting
- Highly abrasion resistant
- Colour break camouflage makes it very hard to spot on lakebed
- Great knot strength and low memory



Light Camo	Dark Camo	Breaking Strain	Diameter	Metres on Spool	*RRP
CML132	CML136	13lb/5.90kg	0.30mm	1000m	£21.99
CML133	CML137	16lb/7.27kg	0.33mm	1000m	£21.99
CML134	CML138	18lb/8.18kg	0.35mm	1000m	£21.99
CML135	CML139	20lb/9.09kg	0.37mm	1000m	£21.99

TRANS KHAKI TAPERED MONO LEADERS

- Designed to take 'shock' of casting a heavy lead or spod long distances and prevent 'crack-offs' from occurring
- Taper allows you to use a thick shock leader but only have a small knot attaching it to main line which aids the distances you can achieve
- Trans Khaki camouflage
- Low memory and low stretch
- Highly abrasion resistant
- 3 leaders per spool each on 12m long
- Available in 12lb-30lb (0.33mm-0.50mm) and 16lb-35lb (0.37mm-0.57mm)



		Breaking Strain	Diameter	Metres on Spool	*RRP
CML142	Edges Soft Tapered Leaders Trans Khaki x 3 12-30lb			100m	£9.99
CML143	Edges Soft Tapered Leaders Trans Khaki x 3 16-35lb			100m	£9.99

EXOCET® TRANS KHAKI TAPERED MONO

- Low visibility Trans Khaki blends virtually disappears on lakebed and in midwater
- Starts at a very strong 35lb (0.50mm) for 8m then the line tapers down over the next 6m to either 12lb (0.30mm) or 15lb (0.33mm) there is then 300m of 12 or 15lb line before it then tapers back up to the 35lb (again 6m of taper and 8m of 35lb).
- Ideal for venues where leaders are banned
- Perfect for distance casting
- Can achieve casts in excess of 180m!
- Double taper means the line can be reversed giving you greater value for money
- Very supple yet highly abrasion resistant
- Great knot strength and low memory
- Supplied on 300m spools



		*RRP
CML155	Exocet Trans Khaki Tapered Leader Line 12-35lb	£10.99
CML156	Exocet Trans Khaki Tapered Leader Line 15-35lb	£10.99

TORQUE®

- Perfect all round monofilament main line
- Offers unrivalled value for money
- Designed for anglers on a tight budget that still want Fox quality
- Low visibility green colour that is perfect for clear water conditions
- Great abrasion resistance makes it ideal for weedy and snaggy venues
- Low diameter aids casting performance
- High knot strength
- Low memory and stretch
- 1000m per spool except 20lb (850m) & 25lb (750m)
- Available in 11lb (0.30mm), 13lb (0.33mm), 16lb (0.35mm), 20lb (0.38mm) and now 25lb (0.42mm)



		*RRP
CML145	Torque 0.30mm 11lb/5.00kg	£9.99
CML146	Torque 0.33mm 13lb/5.91kg	£9.99
CML147	Torque 0.35mm 16lb/7.27kg	£9.99
CML148	Torque 0.38mm 20lb/9.55kg	£9.99
CML157	Torque 0.42mm 25lb/11.73kg	NEW £9.99

SNAG LEADER

- Highly abrasion resistant
- Low stretch properties
- Perfect leader material when fishing snaggy and weedy venues
- Available in Clear and Camo
- Available in 25lb (11.3kg), 35lb (15.9kg) and 45lb (20.4kg)



	Clear	Camo	Breaking Strain	Diameter	Metres on Spool	*RRP
CML065		CML062	25lb/11.3kg	0.45mm	100m	£9.99
CML066		CML063	35lb/15.9kg	0.50mm	100m	£9.99
CML067		CML064	45lb/20.4kg	0.60mm	100m	£9.99

ILLUSION® TRANS KHAKI

- Features cutting-edge technology that makes it our best fluorocarbon ever
- Developed alongside top diver Rob Hughes to ensure it disappears both on the lakebed and up in the water column
- Super-supple for smooth casting and following lakebed contours
- Extremely fast sinking
- Low stretch
- Invisible when in water
- Highly abrasion resistant
- Top quality knot strength
- Supplied on 200m spools
- 600m bulk spools also available



	Breaking Strain	Diameter	Metres on Spool	*RRP
CML130	16lb/7.27kg	0.35mm	200m	£21.99
CML131	19lb/8.64kg	0.39mm	200m	£21.99
CML140	16lb/7.27kg	0.35mm	600m	£54.99
CML141	19lb/8.64kg	0.39mm	600m	£54.99

SURFACE™

- Designed specifically for surface fishing
- Neutral buoyancy
- Low diameter and low visibility
- Ultra-supple for easy casting
- Very discreet when lying on water's surface
- Great abrasion resistance and tough knot strength
- Supplied on 250m spools



	Breaking Strain	Diameter	Metres on Spool	*RRP
CML128	12lb/5.45kg	0.28mm	250m	£8.99
CML129	15lb/6.80kg	0.30mm	250m	£8.99

SUBMERGE®

- Used by many of the best anglers across Europe on some of the most demanding venues
- Available in Dark Camo featuring our colour break technology
- Fast sinking
- Low diameter and very supple for casting performance
- Supple nature helps it to hug lakebed contours
- Highly abrasion resistant
- Virtually zero stretch
- Perfect for snaggy and weedy venues
- Available in 300m and 600m spools
- New 55lb version now available!



	Breaking Strain	Diameter	Metres on Spool	*RRP
CBL008	25lb/11.3kg	0.16mm	300m	£32.99
CBL009	25lb/11.3kg	0.16mm	600m	£64.99
CBL010	40lb/18.1kg	0.20mm	300m	£32.99
CBL011	40lb/18.1kg	0.20mm	600m	£64.99
CBL016	55lb/24.9kg	0.30mm	300m	NEW £34.99
CBL017	55lb/24.9kg	0.30mm	600m	NEW £69.99

HORIZON® SEMI BUOYANT BRAID

- Semi-buoyant design for fishing at extreme long range, which helps to keep the line above weed and snags
- Features the same Dark Camo as our Submerge sinking braid
- Highly abrasion resistant making it perfect for snaggy and weedy venues
- High knot strength
- Very supple making it very smooth when casting
- Low diameter aids distance that can be cast
- Available in 35lb (0.20mm) and 50lb (0.30mm) versions
- Available on 300m spools



	Breaking Strain	Diameter	Metres on Spool	*RRP
CBL014	35lb/15.90kg	0.20mm	300m	£32.99
CBL015	50lb/22.73kg	0.30mm	300m	£32.99

EXOCET® MK2 MARKER BRAID

- Purposely designed for use on a marker reel
- Low visibility green colour reduces chances of carp spooking
- Designed specifically for feature-finding work
- Ultra-buoyant
- Virtually no stretch, which helps transmit every lump and bump on the lakebed back to your rod tip
- Low diameter and supple for distance casting
- High knot strength
- Recommend to use in conjunction with shock leader



	Breaking Strain	Diameter	Metres on Spool	*RRP
CBL012	20lb/9.07kg	0.18mm	300m	£29.99

EXOCET® MK2 SPOD BRAID

- Hi-vis yellow braid designed specifically for spodding
- Ultra-buoyant makes it easier to retrieve your spod
- Virtually no stretch
- Low diameter and supple for distance casting
- High knot strength
- Recommend to use in conjunction with shock leader



	Breaking Strain	Diameter	Metres on Spool	*RRP
CBL013	20lb/9.07kg	0.18mm	300m	£29.99





SHELTERS

Here at Fox our dedicated team of product designers are always striving to produce the perfect shelters for carp fishermen. Appreciating that the needs and wants of carp anglers vary greatly depending on the style of fishing they do; our team, set about ensuring our range for 2018 is the most complete we have ever had.

Many of the great shelters that featured in the 2017 catalogue remain, simply because they are such good designs that offer our customers unrivalled value for money. That said, we do have some new additions for you including three new Royale pram-hood models, a 60ins umbrella plus an exciting new brolly range, that goes by the name of Ultra 60. The Ultra 60 supersedes the Supa Brolly range that reinvigorated and revolutionised the carp fishing umbrella market during recent years. With access to higher quality fabrics and materials, plus a number of clever design tweaks, the Ultra 60 range is set to be our most successful brolly range to date and we feel certain if you are a brolly angler you're going to love what you see, and if you're not currently a brolly user then what awaits you may just change your mind!

Whether you are looking for a large, comfortable long session shelter that is capable of housing multiple people, or a compact, lightweight shelter for those shorter sessions you are sure to find something over the coming pages that ticks all of your boxes...

At the end of this section you will also find a selection of essential items including bivvy tables, headtorches, bivvy lights, mats and cookware.



Front drain pipe diverts water



Mozzie mesh vents at rear



Compression bell cap with rubber gasket



Multiple pegging points



20.000HH Ven-Tec Rip Stop fabric



Internal vapour shield supplied

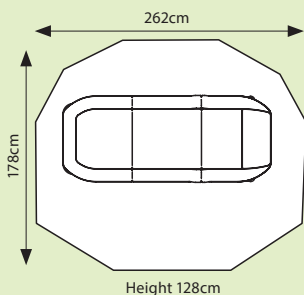

Dimensions of internal floor space



NEW

ULTRA 60 BROLLY

- Features Ventec Rip Stop fabric in khaki colour that has a 20,000mm hydro static head
- Features a full zip on the front to allow an optional Ultra Brolly Full Front or Ultra Brolly Camo Mozzie Screen to be added at a later date
- Supplied with removable internal vapour shield to help reduce condensation and aid comfort (vapour shield can be left attached when packed away)
- Features button-release STS Equipped mechanism, which allows for maximum headroom
- 60ins (152cm) design with 8mm Fibreglass frame for incredible stability
- Four back ribs touch the ground for added stability
- Extended side skirts provide extra protection from the elements
- Rear mozzie mesh vents for added airflow
- Front drain pipe diverts rain water
- Other features include: rod retaining straps, multiple pegging points for adjustable brolly height, compression bell cap with rubber gasket seal
- Short threaded centre pole for ease and speed when erecting
- Four storm caps (supplied with two 24ins side storm poles)
- Protective caps to secure the side storm poles when folded into the brolly once packed away
- Also supplied with: full size heavy duty groundsheet, heavy duty pegs and heavy duty carry bag with full length zip

Main outer fabric: 100% Polyester
 Weight: 10.6kg (everything included), Vapour Shield 600g,
 Groundsheet 1.4kg

ULTRA 60 CAMO MOZZIE SCREEN

- Unique Fox Camo styling
- Full-length integrated zip, which attaches to an open front Ultra Brolly or Ultra Brolly Camo
- Two-way zips on door to create letter box opening
- Elasticated toggle attachments for front storm poles
- Main outer fabric: 100% Polyester



		*RRP
CUM219	Ultra 60 Brolly Khaki	£269.99
CUM223	Ultra 60 Brolly Mozzie Screen Camo	£39.99





NEW

ULTRA 60 BROLLY SYSTEM

- Features Ventec Rip Stop fabric in khaki colour that has a 20,000mm hydro static head
- Supplied with zip-on, fully removable Ultra Brolly Full Front that features three door options: clear PVC, solid khaki and mozzly mesh
- All doors on front feature two-way zips to create letter box opening
- Front panel also features side mozzly mesh windows for added airflow and increased visibility whilst still being protected from bugs
- Optional Ultra Brolly Camo Mozzly Screen can be added at a later date
- Supplied with removable internal vapour shield to help reduce condensation and aid comfort (vapour shield can be left attached when packed away)
- Features button-release STS Equipped mechanism, which allows for maximum headroom
- 60ins (152cm) design with 8mm fibreglass frame for incredible stability
- Four back ribs touch the ground for added stability
- Extended side skirts provide extra protection from the elements
- Rear mozzly mesh vents for added airflow
- Front drain pipe diverts rain water
- Other features include: rod retaining straps, multiple pegging points for adjustable broolly height, compression bell cap with rubber gasket seal
- Short threaded centre pole for ease and speed when erecting
- 4 storm caps (supplied with 2 x 36ins front and 2 x 24ins side storm poles)
- Protective caps to secure the side storm poles when folded into the broolly once packed away
- Also supplied with: full size heavy duty groundsheet, heavy duty pegs and heavy duty carry bag with full length zip

Main outer fabric: 100% Polyester

Weight: 12.9kg (everything included), Vapour Shield 600g, Groundsheet 1.4kg

ULTRA 60 KHAKI INFILL PANEL

- Full-length integrated zip, which attaches to an open front Ultra Brolly to convert it into a full system
- Large mozzly mesh side windows for added airflow and increased visibility whilst still being protected from bugs
- Three door options: clear PVC, solid khaki and mozzly mesh
- All doors on front feature two-way zips to create letter box opening
- Main outer fabric: 100% Polyester



System supplied with three door options - solid...



...clear PVC...



...and mozzly mesh



Two rod retaining straps



Front is fully removable on System



STS equipped mechanism

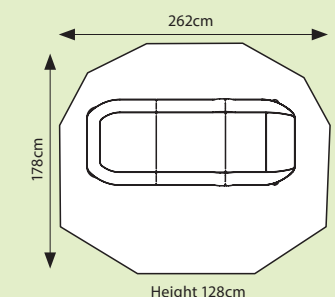

□ Dimensions of internal floor space

		*RRP
CUM220	Ultra 60 Brolly System Khaki	£384.99
CUM224	Ultra 60 Brolly Infill Panel Khaki	£129.99



Internal vapour shield supplied



Compression bell cap with rubber gasket



Multiple pegging points



Mozzie mesh vents at rear



Optional front support pole supplied



20.000HH Ven-Tec Rip Stop fabric

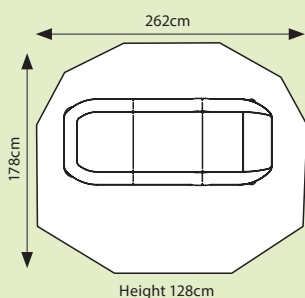

Dimensions of internal floor space



NEW

ULTRA 60 CAMO BROLLY

- Features unique Fox Camo Ventec Rip Stop fabric that has a 20,000mm hydro static head
- Features a full zip on the front to allow an optional Ultra Brolly Camo Full Front or Ultra Brolly Camo Mozzie Screen to be added at a later date
- Supplied with removable internal vapour shield to help reduce condensation and aid comfort (vapour shield can be left attached when packed away)
- Features button-release STS Equipped mechanism, which allows for maximum headroom
- 60ins (152cm) design with 8mm Fibreglass frame for incredible stability
- Four back ribs touch the ground for added stability
- Extended side skirts provide extra protection from the elements
- Rear mozzie mesh vents featuring unique Fox Camo for added airflow
- Front drain pipe diverts rain water
- Other features include: rod retaining straps, multiple pegging points for adjustable brolly height, compression bell cap with rubber gasket seal
- Short threaded centre pole for ease and speed when erecting
- Four storm caps (supplied with two 24ins side storm poles)
- Protective caps to secure the side storm poles when folded into the brolly once packed away
- Also supplied with: full size heavy duty groundsheet, heavy duty pegs and heavy duty carry bag with full length zip

Main outer fabric: 100% Polyester

Weight: 10.6kg (everything included), Vapour Shield 600g, Groundsheet 1.4kg

ULTRA 60 CAMO MOZZIE SCREEN

- Unique Fox Camo styling
- Full-length integrated zip, which attaches to an open front Ultra Brolly or Ultra Brolly Camo
- Two-way zips on door to create letter box opening
- Elasticated toggle attachments for front storm poles
- Main outer fabric: 100% Polyester



		*RRP
CUM221	Ultra 60 Brolly Camo	£289.99
CUM223	Ultra 60 Brolly Mozzie Screen Camo	£39.99



NEW

ULTRA 60 CAMO BROLLY SYSTEM

- Features Ventec Rip Stop fabric in unique Fox Camo that has a 20,000mm hydro static head
- Supplied with zip-on, fully removable Ultra Brolly Camo Full Front that features three door options: clear PVC, solid Fox Camo and Fox Camo mozzie mesh
- All doors on front feature two-way zips to create letter box opening
- Front panel also features side mozzie mesh windows in Fox Camo for added airflow and increased visibility whilst still being protected from bugs
- Optional Ultra Brolly Camo Mozzie Screen can be added at a later date
- Supplied with removable internal vapour shield to help reduce condensation and aid comfort (vapour shield can be left attached when packed away)
- Features button-release STS Equipped mechanism, which allows for maximum headroom
- 60ins (152cm) design with 8mm fibreglass frame for incredible stability
- Four back ribs touch the ground for added stability
- Extended side skirts provide extra protection from the elements
- Rear mozzie mesh vents in Fox Camo for added airflow
- Front drain pipe diverts rain water
- Other features include: rod retaining straps, multiple pegging points for adjustable broolly height, compression bell cap with rubber gasket seal
- Short threaded centre pole for ease and speed when erecting
- Four storm caps (supplied with 2 x 36ins front and 2 x 24ins side storm poles)
- Protective caps to secure the side storm poles when folded into the broolly once packed away
- Also supplied with: full size heavy duty groundsheet, heavy duty pegs and heavy duty carry bag with full length zip

Main outer fabric: 100% Polyester

Weight: 12.9kg (everything included), Vapour Shield 600g, Groundsheet 1.4kg

ULTRA 60 CAMO INFILL PANEL

- Full-length integrated zip, which attaches to an open front Ultra Brolly or Ultra Brolly Camo to convert it into a full system with Fox Camo front
- Large mozzie mesh side windows in Fox Camo for added airflow and increased visibility whilst still being protected from bugs
- Three door options: clear PVC, solid in Fox Camo and Fox Camo mozzie mesh
- All doors on front feature two-way zips to create letter box opening
- Main outer fabric: 100% Polyester



System supplied with three door options - solid...



Front drain pipe diverts water



Heavy duty groundsheet



...clear PVC...



...and mozzie mesh



Front is fully removable on System

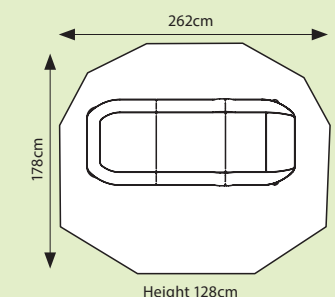

Dimensions of internal floor space

		*RRP
CUM222	Ultra 60 Brolly Camo	£399.99
CUM225	Ultra 60 Brolly Infill Panel Camo	£134.99



Mozzy mesh door



Fully removable front and inner dome



PVC door

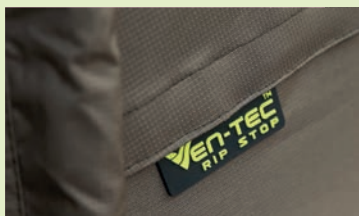

Ven-Tec Rip Stop material



Side support bar



Side mozzy mesh vents

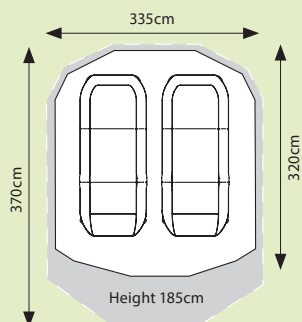

Dimensions of internal floor space

Dimensions including wrap (available separately)

26.85kg



RETREAT+ 2-MAN

- Quite possibly the most feature-packed pram hood bivvy ever made!
- 20,000 hydrostatic head Ven-Tec Rip Stop material
- Perfect for the long session angler or angler who takes a partner with them
- Rigid, lightweight aluminium poles
- Flat back combined with improved side angles gives maximum space both front to back and also side to side
- Break in the pole structure, increases internal space yet makes the bivvy more compact once packed away
- Fully removable front
- Three door options supplied: Solid, clear PVC and Mozzy Mesh
- Two-way zips on all doors for barn-style opening
- Front peak for added protection from elements
- Mozzy mesh window panels at front
- Rear and side mozzy mesh vents for increased air flow
- Adjustable tension straps on side
- Two rod support straps on peak
- Mesh inner dome for added comfort available separately or can be purchased as part of a bivvy & dome package
- Mesh inner dome features zip-in groundsheet
- Can be packed away with mesh dome attached as long as groundsheet is zipped out
- Extending wrap available separately

SUPPLIED WITH

- Full frame support including side support poles for peak
- Storm straps give extra stability
- Heavy duty pegs
- Heavy duty clip-in groundsheet
- Oversized carry bag



RETREAT+ 2-MAN EXTENDING WRAP

- 20,000 hydrostatic head Ven-Tec Rip Stop material
- Same three door options supplied as on bivvy: solid, clear PVC and mozzy mesh
- Mozzy mesh vents on rear and side mirror those on bivvy for added airflow when wrap is on
- Fully removable front
- Creates twin skin effect to reduce condensation, give added warmth in winter and help keep you cool in summer
- Two rod support straps
- Increases overall footprint of bivvy by extending front
- Supplied with additional groundsheet extension

		*RRP
CUM202	Retreat+ 2 Man	£579.99
CUM204	Retreat+ 2 Man Inner Dome	£129.99
CUM206	Retreat+ 2 Man Bivvy & Inner Dome	£679.99
CUM203	Retreat+ 2 Man Extending Wrap	£329.99



RETREAT+ 1-MAN

- Feature-packed design that makes it our best 1-Man bivvy ever!
- 20,000 hydrostatic head Ven-Tec Rip Stop material
- Rigid, lightweight aluminium poles
- Flat back combined with improved side angles gives maximum space both front to back and also side to side
- Fully removable front
- Three door options supplied: Solid, clear PVC and mozzly mesh
- Two-way zips on all doors for barn-style opening
- Front peak for added protection from elements
- Mozzly mesh window panels at front
- Rear mozzly mesh vents for increased air flow
- Adjustable tension straps on side
- Two rod support straps on peak
- Mesh inner dome for added comfort available separately or can be purchased as part of a bivvy and dome package
- Mesh inner dome features zip-in groundsheet
- Can be packed away with mesh dome attached as long as groundsheet is zipped out
- Extending Wrap available separately

SUPPLIED WITH

- Full frame support
- Heavy duty pegs
- Heavy duty clip-in groundsheet
- Oversized carry bag



RETREAT+ 1-MAN EXTENDING WRAP

- 20,000 hydrostatic head Ven-Tec Rip Stop material
- Same three door options supplied as bivvy: solid, clear PVC and mozzly mesh
- Mozzly mesh vents mirror those on bivvy for added airflow when wrap is on
- Fully removable front
- Creates twin skin effect to reduce condensation, give added warmth in winter and help keep you cool in summer
- Increases overall footprint of bivvy by extending front
- Two rod support straps
- Supplied with additional groundsheet extension



Mozzly mesh door



Fully removable front and inner dome



PVC door



Ven-Tec Rip Stop material



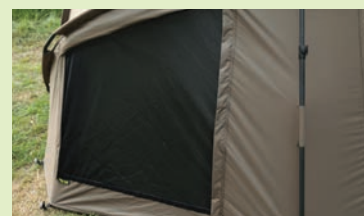

Side tension straps

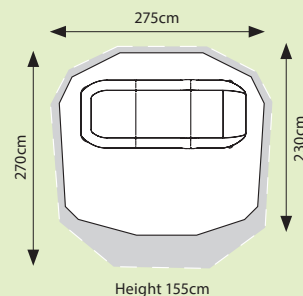

Rear mozzly mesh vents



 Dimensions of internal floor space
 Dimensions including wrap (available separately)

 **18.75kg**

		*RRP
CUM199	Retreat+ 1 Man	£499.99
CUM201	Retreat+ 1 Man Inner Dome	£109.99
CUM205	Retreat+ 1 Man Bivvy & Inner Dome	£529.99
CUM200	Retreat+ 1 Man Extending Wrap	£249.99



Mozzy mesh door



PVC door



Fully removable front



Barn-style door

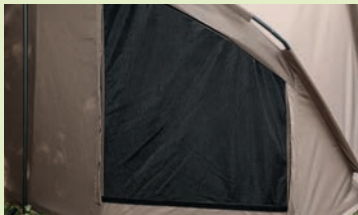

Rear mozzy mesh



Frame support poles

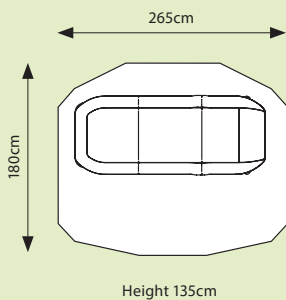

□ Dimensions of internal floor space

13.75kg



RETREAT+ COMPACT

- 20,000 hydrostatic head Ven-Tec Rip Stop material
- This model is perfect for tight swims and for anglers that like to scale their kit down
- Rigid, lightweight aluminium poles
- Flat back combined with improved side angles gives maximum space both front to back and also side to side
- Break in the pole structure, increases internal space yet makes the bivvy more compact once packed away
- Fully removable front
- Three door options supplied: Solid, clear PVC and mozzy mesh
- Two-way zips on all doors for barn-style opening
- Front peak for added protection from elements
- Mozzy mesh window panels at front
- Rear mozzy mesh vents for increased air flow
- Adjustable tension straps on side
- Two rod support straps on peak
- Skin available separately

SUPPLIED WITH

- Full frame support
- Heavy duty pegs
- Heavy duty clip-in groundsheet
- Oversized carry bag

RETREAT+ COMPACT SKIN

- Open front design
- 20,000 hydrostatic head Ven-Tec Rip Stop material
- Creates twin skin effect to reduce condensation, give added warmth in winter and help keep you cool in summer
- Rear mozzy mesh vents match those on bivvy
- Rod support straps at front



		*RRP
CUM197	Retreat+ Compact	£399.99
CUM198	Retreat+ Compact Skin	£159.99

EASY DOME **FOX**
2 MAN EURO MAXI



EASY DOME® MAXI 2-MAN EURO

- Perfect for long session anglers that require lots of space!
- Larger foot print and higher than standard 2-Man Maxi
- New frame design with additional rear rib for flat back profile that gives increased usable internal space
- Additional rib also increases stability
- Rear mozy mesh vents for increased airflow
- 100% Polyester fabric with 6,000mm hydrostatic head
- Fully removable front
- Aero-grade aluminium poles
- Unique Fox Snap Lock elbows
- Fully removable front panel system
- Mozy mesh front side panels
- Velcro rod retaining straps
- Removable inner mozy mesh sleeping compartment with newly designed removable PE groundsheet (easier to pack away and clean)
- Integrated guy ropes for extreme weather situations
- Easy and speedy erection time
- Supplied with mozy mesh, solid and PVC door options
- All doors have two way zips for barn-style opening
- Supplied with pegs and new-design carry bag
- Heavy duty groundsheet available separately



Mozy mesh door



PVC door



Removable front



Solid front door



Aero-grade aluminium poles

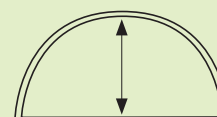

18.25kg

- Max height inside tent 170cm
- Height back from bottom to rib 154cm
- Height front from bottom to rib 154cm
- Door opening from bottom to zip 140cm
- Door opening at widest point 95cm

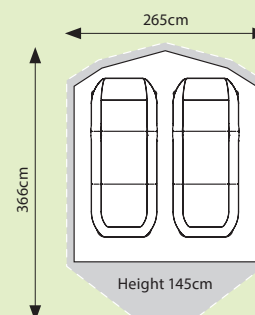

□ Dimensions of internal floor space
 ■ Dimensions including wrap (available separately)

		*RRP
CUM192	Easy Dome Maxi 2-Man Euro	£529.99
CUM195	Heavy Duty Groundsheet	£49.99



Mozzy mesh door



PVC door



Removable front



Solid front door



Barn style door

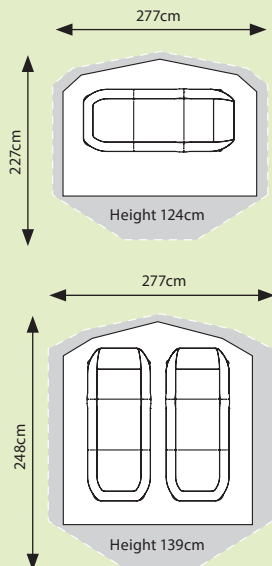

□ Dimensions of internal floor space
 ■ Dimensions including wrap (available separately)

EASY DOME **FOX**
 2 MAN MAXI



EASY DOME **FOX**
 1 MAN MAXI



EASY DOME® MAXI 1 MAN & 2 MAN

- New frame design with additional rear rib for flat back profile that gives increased usable internal space
- Additional rib also increases stability
- Rear mozzy mesh vents for increased airflow
- 100% Polyester fabric with 6,000mm hydrostatic head
- Fully removable front
- Aero-grade aluminium poles
- Unique Fox Snap Lock elbows
- Fully removable front panel system
- Mozzy mesh front side panels
- Velcro rod retaining straps
- Removable inner mozzy mesh sleeping compartment with newly designed removable PE groundsheet (easier to pack away and clean)
- Integrated guy ropes for extreme weather situations
- Easy and speedy erection time
- Supplied with mozzy mesh, solid and PVC door options
- All doors have two way zips for barn-style opening
- Supplied with pegs and new-design carry bag
- Heavy duty groundsheet available separately

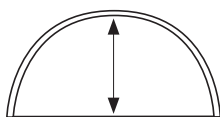

14.30kg

- Max height inside tent 138cm
- Height back from bottom to rib 134cm
- Height front from bottom to rib 134cm
- Door opening from bottom to zip 118cm
- Door opening at widest point 92cm

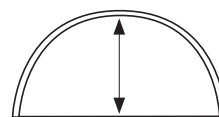

15.35kg

- Max height inside tent 154cm
- Height back from bottom to rib 148cm
- Height front from bottom to rib 148cm
- Door opening from bottom to zip 132cm
- Door opening at widest point 93cm

		*RRP
CUM190	Easy Dome Maxi 1-Man	£399.99
CUM193	Heavy Duty Groundsheet	£34.99

		*RRP
CUM191	Easy Dome Maxi 2-Man	£449.99
CUM194	Heavy Duty Groundsheet	£39.99





EASY SHELTER

- Unique pop-up frame design for rapid erection and very fast pack away
- Perfect shelter for short session angler who wants something that is light and compact to carry
- Ideal for tight swims where a traditional brolly or bivvy wouldn't fit
- Heavy wearing Polyester fabric (2000mm hydrostatic head rating)
- Styled in unique Fox Camo pattern
- Can fit inside a bedchair when packed away for easy transportation
- Front peak gives protection from rain when door is open
- Can be pegged to the ground for maximum stability and making it ideal for use as a day session shelter when not carrying a bedchair
- Solid front option features three vertical toggle fixings to allow you to roll the panel up in sections and peg out further to give increased coverage when in use
- Supplied with zip-in mozzie mesh front panel
- Large mozzie mesh panel at rear to aid air flow
- Both front panels feature letter box style door
- Designed to fit most standard sized bedchairs
- Rod straps either side of the door
- Supplied with three support ribs and heavy-duty pegs

CUM187 Easy Shelter Camo *RRP
£159.99

POP UP DESIGN...



Solid front door



Mozzie mesh door



Pegged out adjustable front



Frame support



Can be packed inside a bedchair

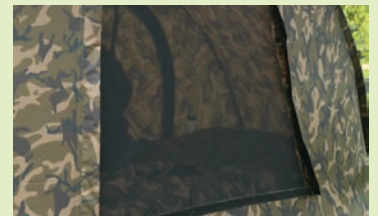

Rear mozzie mesh vents for air flow

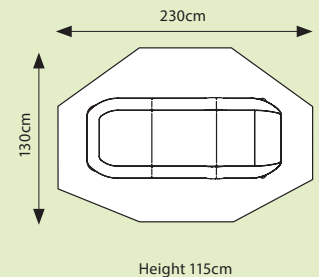

 Dimensions of internal floor space



Solid front panel



Full mozzoy mesh front



PVC front

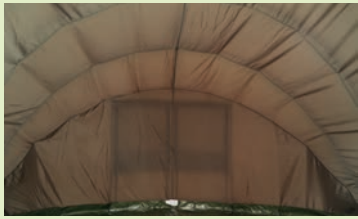

Internal mesh dome



Reinforced doorstep



Zip-in heavy duty groundsheet

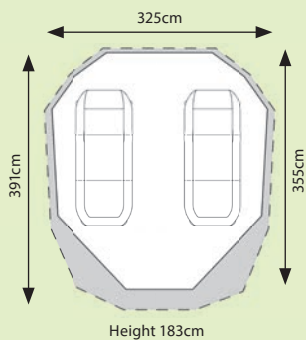

Height 183cm

- Dimensions of internal floor space
- Dimensions including wrap (available separately)



ROYALE® XXL EURO

- Result of numerous requests from continental anglers who wanted a massive bivvy with an internal mesh dome, similar to that of an Easy Dome design
- Based on original, top-selling Royale XXL
- Inner mesh dome aids comfort and helps to prevent condensation
- Mesh vents at rear
- Mesh panels on door and side windows
- Internal mesh storage pockets
- Full frame support
- Front support poles
- Adjustable tension straps on side
- Reinforced doorstep to keep insects and rodents out and also help door keep its shape
- Heavy duty groundsheet and pegs
- Supplied in oversized carry bag
- Rod straps at front
- Rigid aluminium pole structure
- 5000 hydrostatic head hardwearing polyester fabric
- Height: 183cm
- Main outer fabric: 100% Polyester

ROYALE® XXL EURO WRAP

- Makes XXL Euro larger
- Increases warmth in winter and helps to keep you cool in summer
- Reduces condensation
- Rear vents match those on bivvy
- PVC and mesh front door supplied



		*RRP
CUM152	Royale XXL Euro	£629.99
CUM139	Royale XXL Extending Skin	£199.99

 **ROYALE** **XXL**



ROYALE® XXL

- Our number one selling bivvy across Europe
- Packed with features for the long session angler to enjoy
- Constructed from a hardwearing Polyester fabric with a 5000 hydrostatic head
- Rigid aluminium pole structure and the poles have a textured black powder coating
- Larger back panel and longer rear rib, which increases space inside the bivvy
- Two rod straps on front
- Mozy panelled front door and mozy panels on either side of the door and at rear
- Toggles allow front door to roll up to the full bivvy height, as if it has been zipped off
- Top quality heavy duty zips
- Supplied with heavy duty clip-in groundsheet
- Clear door panel supplied
- Two front door pegging points allow you to change height
- Pegging points come with elasticated tension straps
- Heavy-duty pegs supplied
- Height: 183cm
- Hydrostatic head 5000mm

ROYALE® XXL WRAP

- Makes XXL larger
- Increases warmth in winter and helps to keep you cool in summer
- Reduces condensation
- Rear vents match those on bivvy
- PVC and mesh front door supplied



PVC door



Full mozy mesh front



Roll up open front



Additional space created by wrap





Mesh on wrap front matches shelter mesh

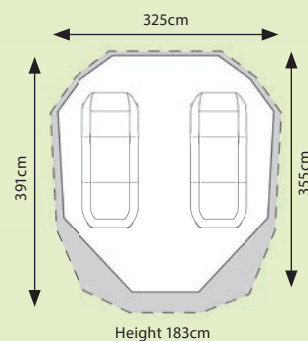

Two-way front door



 Dimensions of internal floor space

 Dimensions including wrap (available separately)

		*RRP
CUM137	Royale XXL	£399.99
CUM139	Royale XXL Extending Skin	£199.99



Mesh door and window option



PVC door supplied



Roll up front



Supplied with internal mesh dome



Rear mozzie mesh panels



Two-way door system

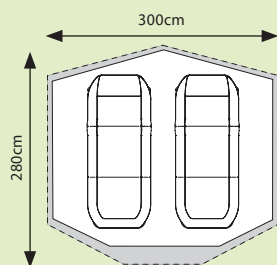

Height 170cm

Dimensions of internal floor space
 Dimensions including wrap (available separately)



NEW

ROYALE® EURO DOME 2-MAN

- Based on same design as Royale Euro Dome 1-Man but with a larger footprint
- Supplied with removable inner dome for added comfort
- Inner dome can be left attached once all groundsheets have been removed
- Hardwearing, breathable polyester fabric with 2500mm hydrostatic head rating
- Supplied with heavy duty groundsheet and lightweight zip in groundsheet for inner dome
- Mozzie mesh panels on front, rear and door panel to aid airflow
- Front panel can be rolled back to create open front design
- Adjustable frame tension straps
- Supplied with clear PVC, solid and mozzie mesh panels that all feature double zips
- Rod straps positioned either side of front door
- Supplied with heavy duty pegs, oversized carry bag and full frame support

ROYALE® EURO DOME 2-MAN SKIN

- Creates a twin skin
- Increases warmth in winter and helps to keep you cool in summer
- Reduces condensation



		*RRP
CUM214	Royale Euro Dome 2-Man	£399.99
CUM215	Royale Euro Dome 2-Man Skin	£129.99



ROYALE® EURO DOME 1-MAN

- Based on same design as original award-winning Royale Classic 1-Man
- Supplied with removable inner dome for added comfort
- Inner dome can be left attached once all groundsheets have been removed
- Footprint of the shelter has been made slightly larger than Royale Classic 1-Man to allow for the footprint of the inner dome to be approximately the same size as the Classic 1-Man
- Hardwearing, breathable polyester fabric with 2500mm hydrostatic head rating
- Supplied with heavy duty groundsheet and lightweight zip in groundsheet for inner dome
- Mozy mesh panels on front, rear and door panel to aid airflow
- Front panel can be rolled back to create open front design
- Adjustable frame tension straps
- Supplied with clear PVC, solid and mozy mesh panels that all feature double zips
- Rod straps positioned either side of front door
- Supplied with heavy duty pegs, oversized carry bag and full frame support

SUPPLIED WITH

- Full frame support
- Heavy duty pegs
- Oversized carry bag



Mesh door and window option



Internal mesh dome



Two-way door system



Frame support



Internal mesh storage pockets



Mozy mesh rear vents for airflow

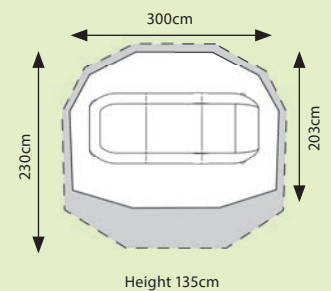

□ Dimensions of internal floor space
 ■ Dimensions including wrap (available separately)

CUM186 Royale Euro Dome 1-Man *RRP £299.99



Solid front panel



Clear door



Roll up open front



Two rod retaining straps at front of shelter



Adjustable tension straps for taught fabric



Classic skin comes with frame support bars

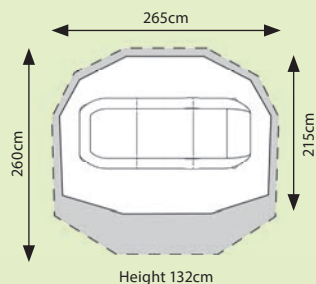

□ Dimensions of internal floor space
 □ Dimensions including wrap (available separately)



ROYALE® CLASSIC

- Two rib pram hood design
- Perfect for newcomers and anglers on a tight budget that still want Fox quality
- Full frame support supplied
- Adjustable tension straps on both sides
- Mozy mesh panel on the front panels and door to aid airflow
- PVC door option also supplied
- Two-way letterbox style door
- Front can be rolled up to create an open fronted shelter
- Two rod straps on front of shelter
- Heavy duty pegs supplied
- Made from a hard wearing, breathable Polyester fabric with Hydrostatic head rating of 2500mm
- Supplied in oversized carry bag
- Overwrap available separately
- Main outer fabric: 100% Polyester

ROYALE® CLASSIC SKIN

- Creates a twin skin
- Increases warmth in winter and helps to keep you cool in summer
- Reduces condensation



		*RRP
CUM148	Royale Classic	£189.99
CUM149	Royale Classic Skin	£79.99



ROYALE® CLASSIC 2-MAN

- Full frame support supplied
- Adjustable tension straps on both sides
- Mozzey mesh panel on the front panels and door to aid airflow
- Large vents at rear also aid airflow in warmer months
- PVC door option supplied
- Two-way letterbox style door
- Whole front can be rolled up to create an open fronted shelter
- Two rod straps on front
- Heavy duty pegs supplied
- Made from a hard wearing, breathable Polyester fabric with Hydrostatic head rating of 2000mm
- Supplied in oversized carry bag
- Weight 13.6kg (including heavy duty groundsheet and pegs)
- Skin available separately (weighing 2.7kg)
- Main outer fabric: 100% Polyester
- Hydrostatic head 2500mm



Mesh front



PVC door panel



Roll up open front



Adjustable tension straps for taught fabric



Two rod retaining straps at front of shelter



Frame support supplied

ROYALE® CLASSIC 2-MAN SKIN

- Creates a twin skin
- Increases warmth in winter and helps to keep you cool in summer
- Reduces condensation

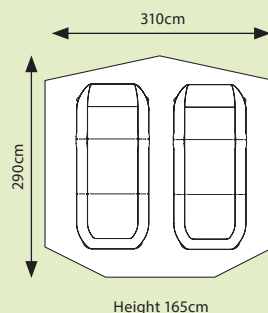

□ Dimensions of internal floor space

		*RRP
CUM171	Royale Classic Two Man	£329.99
CUM172	Royale Classic Two Man Skin	£114.99



PVC door option



Mozzie mesh door supplied



Roll up front



Mozzie mesh rear vents



Adjustable side tension straps



Rod straps at front

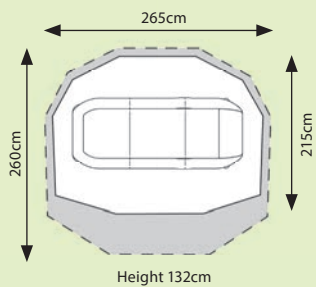

Dimensions of internal floor space
 Dimensions including wrap (available separately)



NEW

ROYALE® CLASSIC 1 MAN CAMO

- Unique Fox Camo pattern on material
 - Full frame support supplied
 - Adjustable tension straps on both sides
 - Front and rear mozzie mesh panels and a mozzie panel on the door to aid airflow
 - PVC door option also supplied
 - Two-way letterbox style door
 - Front can be rolled up to create an open fronted shelter
 - Two rod straps on front of shelter
 - Heavy duty pegs supplied
 - Made from a hard wearing, breathable Polyester fabric
 - Supplied in oversized carry bag
- Weight: 10.8kg (including heavy duty groundsheet and pegs)
 - Main outer fabric: 100% Polyester
 - Hydrostatic Head Rating: 2500mm

*RRP

CUM217 Royale Classic Bivvy Camo 1 Man £209.99

ROYALE
CLASSIC BIVVY **2**
MAN



NEW

ROYALE® CLASSIC 2 MAN CAMO

- Unique Fox Camo pattern on material
- Full frame support supplied
- Adjustable tension straps on both sides
- Front and rear mozzly mesh panels and a mozzly panel on the door to aid airflow
- Features large rear vents
- PVC door option also supplied
- Two-way letterbox style door
- Front can be rolled up to create an open fronted shelter
- Two rod straps on front of shelter
- Heavy duty pegs supplied
- Made from a hard wearing, breathable Polyester fabric
- Supplied in oversized carry bag
- Weight: 13.6kg (including heavy duty groundsheet and pegs)
- Main outer fabric: 100% Polyester
- Hydrostatic Head Rating: 2500mm

*RRP

CUM218 Royale Classic Bivvy Camo 2 Man £319.99



PVC door option



Mozzly mesh door supplied



Mozzly mesh rear vents



Rod straps at front



Full frame support supplied

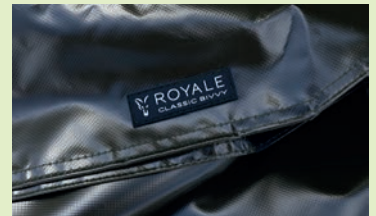

Heavy duty groundsheet as standard

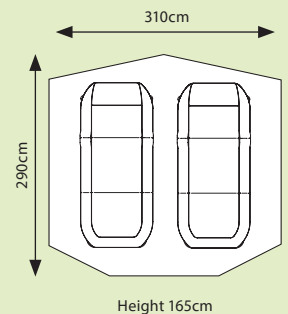

 Dimensions of internal floor space



PVC door



Full mozzey mesh front



Removable front



Also supplied with two side tension bars that offer increased stability



ROYALE® 60 BROLLY SYSTEM

- Space-saving spoke design for increased headroom
- Full removable front system with mozzey mesh sides and mozzey mesh/PVC door window
- Supplied with 4 x storm poles (2 x 24ins (61cm) side poles and 2 x 48ins (122cm) front poles))
- 60ins (152cm) frame
- Four rear ribs touch the ground for added stability
- Lightweight groundsheet supplied
- Two-way zip system on door
- 2 x tension side bars
- 2 x rod straps
- Made from hardwearing, breathable nylon fabric
- Supplied with heavy-duty pegs
- Erection time three minutes approx
- Main outer fabric: 100% Polyester
- Hydrostatic head 5000mm

		*RRP
CUM153	Royale 60" Brolley System	£249.99



ROYALE® 60 BROLLY

- Perfect for anglers that fish short sessions and that like to keep mobile
- Space-saving spoke design for increased headroom
- Supplied with 2 x 24in (61cm) side storm poles
- 60ins (152cm) frame
- Four rear ribs touch the ground for added stability
- 2 x rod straps
- Made from hardwearing, breathable nylon fabric
- Supplied with heavy duty pegs
- Erection time 1 minute approx
- Main outer fabric: 100% Polyester
- Hydrostatic head 5000mm

		*RRP
CUM154	Royale 60" Brolley	£114.99

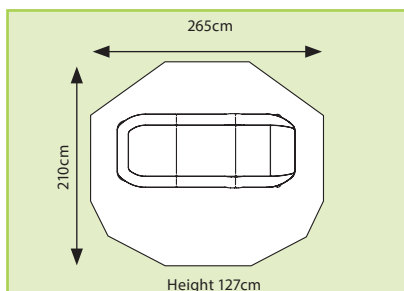

□ Dimensions of internal floor space



Two handy rod retraining straps at front of umbrella



Spokes are 15cm higher up than on a traditional brolley



ROYALE® COOK TENT STATION

- Spacious design to accommodate all cooking apparatus and food for long sessions
- Creates a fantastic social area for your fellow anglers to enjoy
- Steel frame construction
- Same hardwearing breathable 5000 hydrostatic head polyester fabric as used on Royale XXL bivvy
- Mozy mesh panel at rear to aid airflow inside
- Zip-in groundsheet
- Supplied with solid, clear PVC and mozy mesh front panel options
- Front door can be converted with two extra long banksticks (supplied) to create a porch area for extra space
- Access point at rear for electric cables or gas pipes for fridges, cookers etc
- Supplied with guy ropes on each corner and on front of porch for extra stability
- Heavy duty pegs supplied
- Supplied in heavy duty carry bag
- Main outer fabric: 100% Polyester
- Hydrostatic head 5000mm

CUM183 Royale Cook Tent Station ^{*RRP} £219.99



Zip-in heavy-duty groundsheet



Clear PVC front panel option



Mozy mesh front panel option

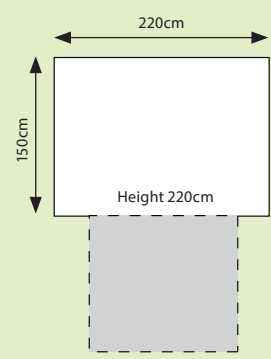

□ Dimensions of internal floor space
 ■ Dimensions including wrap (available separately)



NEW

60INS BROLLY

- A simple 60ins brolly design, which features a removable central pole
- The pole can be positioned Nu-brolly style and used with or without storm poles – this means the central pole can be removed and re-positioned parallel to the back of the brolly. The pole can then be pushed into the ground to offer coverage without the pole being in the way
- Two storm caps are included for optional use of storm poles (not included)
- Hardwearing Khaki coloured polyester fabric (2000mm hydrostatic head)
- Perfect for short day sessions or for extra cover when entertaining visitors in your swim

CUM216 60" Brolly ^{*RRP} £74.99

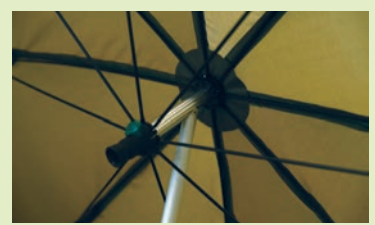

Can also be positioned NU-brolly style



Rear pegging points



BIVVY/ROD MAT

- Robust design
- Full mesh non-slip base
- Neoprene foot wipe
- Heavy duty durable material
- Pegging points in each corner
- Perfect for use as a door mat or to place under rods, reels and indicators to protect them from splashback when it rains
- Available in standard and XL

		*RRP
CUM116	Bivvy/Rod Mat	£17.99
CUM159	XL Bivvy Mat	£27.99



PLATFORM 'S' PEG x 15

- Perfect for pegging your shelter down when fishing on wooden platforms
- Ergonomic handles
- Hardwearing steel point and thread
- 15 in a packet

		*RRP
CUM142	Platform S Pegs x 15	£15.99



BIVVY TABLE

- Surface dimensions measure 49cm x 29cm
- Features two compartments – large for a System F Box and smaller for items such as keys, phone, rig bits etc
- Special non-slip coated surface
- Legs extend to 33cm and are secured by Fox Cam Loks
- Large swivel feet for stability on soft ground

		*RRP
CAC053	Bivvy Table	£39.99

ROYALE® SESSION XL TABLE

- Perfect for long session angler
- Fold flat design
- Four extendable legs with easy to use adjustment. Min/Max height 45-60cm
- Protective table top cover supplied
- Compact when folded away - supplied with carry bag
- Surface dimensions measure 79cm x 59cm

		*RRP
CAC427	Royale Session XL Table	£79.99



WARRIOR® BIVVY TABLE

- Table top measures 47cm x 31cm
- Designed to accommodate a large System F Box
- Extendable legs with Cam Lok fittings
- Legs extend to 31cm
- Fold flat design
- Comes in carry bag

		*RRP
CAC357	Warrior Bivvy Table	£34.99

SESSION TABLE

- Surface dimensions measure 51cm x 34cm
- Special non-slip coated surface
- Legs extend to 33cm and are secured by Fox Cam Loks
- Large swivel feet for stability on soft ground

		*RRP
CAC187	Session Table	£44.99



CANISTER STOVE

- Screws straight into top of gas canister
- Piezo ignition
- Adjustable flame control
- Weighs only 129g
- Compact design
- Supplied with mesh bag and plastic hardcase

		*RRP
CCW007	Cannister Stove inc Mesh Bag/Case	£21.99



HEAT TRANSFER KETTLE

- Features Heat Transfer Technology that helps to concentrate the flame of your stove on the base of the kettle for a much faster boiling time
- Design taken from the camping industry
- Made from a hard anodised aluminium and features a durable soft touch handle
- Approximately 33% more efficient than traditional camping kettle, which boils the kettle fast and saves you money!
- Available in 0.9L and 1.5L versions

		*RRP
CCW005	Heat Transfer Kettle 0.9L	£26.99
CCW006	Heat Transfer Kettle 1.5L	£29.99



WINDSHIELD

- Shields your stove from the wind allowing for greater fuel efficiency
- Lightweight aluminium construction
- Comprises seven hinged panels
- Features pegging pins to aid stability on soft ground
- Supplied with a handy carry bag
- Available in two sizes – Standard and XL

		*RRP
CCW004	Windshield	£11.99
CCW008	XL Windshield	£14.99



3-PIECE MEDIUM COOKSET

- Supplied with frying pan, medium saucepan and 0.9L Heat Transfer Kettle
- Compact for transportation - saucepan sits inside the frying pan and the kettle inside the saucepan
- Thicker aluminium wall than other pans on the market allowing a higher quality non-stick coating to be applied
- Supplied with a drawcord mesh carry bag
- The pans feature durable folding handles to allow them to be packed away in a compact manner
- Compatible with Royale Cookset Bag (see page 101)

		*RRP
CCW001	Medium 3pc Set	£59.99

4-PIECE LARGE COOKSET

- Supplied with larger frying pan, large saucepan, medium saucepan and 0.9L Heat Transfer kettle
- Compact for transportation – kettle sits inside medium saucepan, which then sits inside large saucepan which then sits inside frying pan
- Thicker aluminium wall than other pans on the market allowing a higher quality non-stick coating to be applied
- Supplied with a drawcord mesh carry bag
- The pans feature durable folding handles to allow them to be packed away in a compact manner
- Compatible with Royale Cookset Bag (see page 101)

		*RRP
CCW002	Large 4pc Set	£69.99

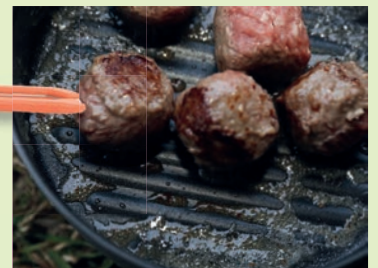

Pans have a high quality non-stick coating



Compatible with Royale Cookset Bag (see page 101)



MS300C is USB rechargeable



Batteries on MS250 are stored in rearcase



All Halo models feature a powerful main beam

NEW

HALO® 200 HEADTORCH

- 200 lumens
- Adjustable brightness (High -200, Medium-100, Low-20 lumens)
- Flashing mode at 25 lumens
- Single elasticated, adjustable head band
- Batteries are positioned at front in head section
- Adjustable angle projection
- Single button operation
- 1 x 3w Gen two LG White LED bulb
- Supplied with 3 x AAA alkaline batteries
- Weight including batteries: 88g

		*RRP
CEI161	Halo 200 Headtorch	£22.99



NEW

HALO® MS250 HEADTORCH

- 250 lumens
- Adjustable brightness (High -250, Medium-100, Low-10 lumens + 3mm LED setting of 15 lumens)
- Bulb type: 1 x Luxeon TX White LED + 2 x 3mm Nichia White LEDs
- Motion sensor (not only useful when tying rigs/cooking, but can be set up on a bankstick by your rods for security)
- Single elasticated, adjustable head band
- Batteries are positioned at rear in separate case (47mm x 89mm x 29mm), which also features light diffuser (ideal for other anglers to see you when you are out in water on a boat)
- Battery power indicator: Turn rear light on, Green LED is high power, Red LED is low power
- Adjustable angle projection
- Two button operation
- Supplied with 3 x AAA alkaline batteries
- Weight including batteries: 135g

		*RRP
CEI162	Halo MS250 Headtorch	£37.99



NEW

HALO® MS300C HEADTORCH

- 300 lumens
- Adjustable brightness (High -300, Medium-100, Low-10 lumens + 3mm LED setting of 15 lumens)
- Bulb type: 1 x Luxeon TX White LED + 2 x 3mm Nichia White LEDs
- USB Rechargeable Li-polymer built-in battery supplied
- Also supplied with Micro USB charging cable
- Motion sensor (not only useful when tying rigs/cooking, but can be set up on a bankstick by your rods for security)
- Single elasticated, adjustable head band
- Charging status indicator on rear: red light indicates charging, green light indicates fully charged
- Battery is positioned at rear in separate case (47mm x 89mm x 29mm), which also features light diffuser (ideal for other anglers to see you when you are out in water on a boat)
- Two button operation
- Weight including battery 130g
- Important Note: Re-charge battery every three months if not being used for a long time. The battery will only reach full performance after a few complete charging and discharging cycles

		*RRP
CEI163	Halo MS300C Headtorch	£48.99





NEW

HALO® AL320 HEADTORCH

- 470 lumens in 'boost' mode
- Adjustable brightness (High -320, Medium-150, Low-25 lumens)
- Bulb type: 1 x XP-G2 Cree White LED
- Light unit made from a hardwearing anodised aluminium
- Single elasticated, adjustable Camo head band
- Batteries are positioned at rear in separate case (53mm x 76mm x 34mm), which also features a red light
- Adjustable angle projection

- Side operation button for front light
- Supplied with 3 x AA alkaline batteries
- Weight including batteries: 195g

*RRP		
CE1164	Halo AL320 Headtorch	£43.99



AL350C is USB rechargeable



Li-ion battery supplied on AL350C



Rear light on battery compartment



NEW

HALO® AL350C HEADTORCH

- 500 lumens in 'boost' mode
- Adjustable brightness (High-350, Medium-150, Low-25 lumens)
- Bulb type: 1 x XP-G2 Cree White LED
- Light unit made from a hardwearing anodised aluminium
- USB Rechargeable Li-ion battery supplied
- Also supplied with Micro USB charging cable
- Single elasticated, adjustable Camo head band
- Battery is positioned at rear in separate case (38mm x 102mm x 35mm), which also features single button operation red light

- Side operation button for front light
- Charging status indicator on rear: Red light indicates charging, green light indicates fully charged
- Weight including battery 190g
- Important Note: Re-charge battery every three months if not being used for a long time. The battery will only reach full performance after a few complete charging and discharging cycles

*RRP		
CE1165	Halo AL350C Headtorch	£59.99





BEDCHAIRS, CHAIRS & SLEEPING BAGS

There is no doubt in our experience that being comfortable when on the bank fishing can make a significant contribution to your success rate. Here at Fox we take bankside comfort very seriously so whether it be a bedchair, sleeping bag or standard chair you can be sure that many hours of research and development have gone into every single one that carries the Fox logo.

When developing our items the goal is very clear, we aim to produce the best products on the market at competitive prices that offer unrivalled value for money. Such has been the response to our bedchairs, chairs and sleeping bags over the past 12 months we have not made lots of changes for 2018. Many items remain because they are of such good quality and in such high demand. However, we do have some new additions: as all of our Warrior bedchairs and chairs have been upgraded and replaced with the Warrior 2 range, whilst we also have some new waterproof covers for our chairs, a Camolite Hot Water Bottle and Pillows plus a new addition to the ERS sleeping bag range too...



**REVOLUTIONARY
FLATLINER
'FLIP-CAM SYSTEM'**



Even Flow elastic on standard Flatliner gives more consistent tension to mattress



Twist-Lok Leg - simply twist the mechanism on the leg with one hand for instant and infinite adjustment



Double Hinge Bracket at the foot end. This creates a void when folded to store a standard 3 season bag



High density foam mattress that is fleece covered and also a staggering 50mm deep!

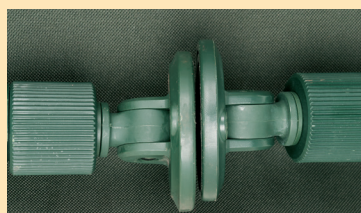

Further leg spacing prevents them from overlapping when the bedchair is packed away

FX FLATLINER® BEDCHAIR

- 'Flip-Cam System', which is a very special piece of innovation. All other bedchairs, once unfolded, have the Cams pointing upwards and as we all know they are a real inconvenience. Not only do they get in the way but they also reduce the width of the mattress that you can actually utilize. This, however, is now a thing of the past as the Cam on the Flatliner swivels 180 degrees so that it points downwards
- 'Twist-Lok' legs, which can be operated with one hand. Simply twist the mechanism on the leg and the foot will fall into position. Then let go of the mechanism and it will automatically lock the leg into position – it couldn't be easier!
- The Flatliner features a unique 'Double Hinge Bracket' on the foot-end that has been designed to create a void inside the bedchair when it is folded away. This therefore allows enough space for a standard-sized 3-season sleeping bag to be folded inside. Some other bedchairs achieve this by putting an angle in the actual frame at the head end, which severely hinders your sleeping position and comfort as you cannot lie flat!
- 'Even Flow' Elastic has several benefits. Most other bedchairs use at least four lengths of elastic, whereas the Flatliner only uses two, which start and finish at the head and foot ends and also run through the Cam (unlike any other bedchair on the market). This means that there are no sections of the mattress that are not elasticated, and therefore gives a much more consistent tension and firmer feel to the mattress
- Mattress utilizes eyelets instead of the fabric loops. Eyelets allow the elastic to stretch when you sit on the bedchair and then retract when you get off of it. In addition the eyelets have been very carefully positioned around the perimeter of the mattress to ensure maximum support is achieved. They are positioned as close as they can be to the legs to ensure an even tension on the mattress
- The frame is constructed from an oval aluminium, which is not only incredibly strong but also makes the frame surprisingly light
- High density foam mattress that is fleece covered and also a staggering 50mm deep!
- Three legged
- Six large mud feet
- Main outer fabric: 100% Polyester
Padding/Filling: 100% Polyurethane

*RRP

CBC039 FX Flatliner Bedchair £329.99

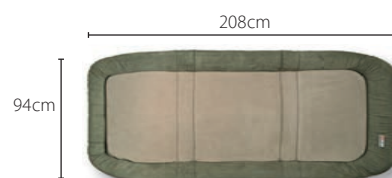

Standard Flatliner

Min height: 40cm, Max height: 48cm. Weight: 12.9kg





Side compression straps enables bed and bag to be packed away more compactly

FLATLITER
BED AND BAG SYSTEM
MK2

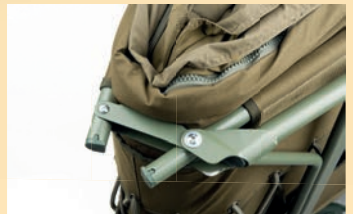

Double hinge enables sleeping bag to be folded up inside in a compact manner

FX FLATLITER® BED & BAG SYSTEM MK2

- Double Hinged Bracket at both head and foot end, eliminating need for Cams
- Two side tension straps that go around frame rather than mattress make it possible to fold away more compact with sleeping bag attached
- Velcro strips on underside of mattress for use with Aquos covers (can secure cover to bed on the side you don't need to exit to keep warmth in)
- High density foam on mattress for greater comfort
- One-piece lumbar support on middle and head section gives a much firmer mattress and prevents sagging
- Unique leg design with single legs at both head and foot end for increased stability and reduced weight, this means you only have 6 legs rather than 8 but still have full support at both ends
- 'Twist Lok' mechanism for infinite leg adjustment as used on Flatliner bedchair
- Large mud feet
- Two sizes available: Standard and Compact
- Main outer fabric: 100% Polyester
Padding: 100% Polyurethane



Single support legs at each end for extra stability

SUPPLIED BAG FEATURES

- Bag attaches to bed via full length zip around edge of mattress to allow greater movement when inside the bag
- Bag lining on bottom half is polyester (allows easy movement inside bag) and top half is fleece (aids warmth and comfort)
- New improved hollow fill used, which aids warmth and is also much softer enabling bag to sculpt around your body
- Larger internal zip baffle to keep warmth in and cold out
- Sleeping bag is rated as a 3-4 season
- Heavy-duty 10mm snag-free, crash zips on sleeping bag
- 20% of the bags filling is below you and the other 80% is above you to prevent heat loss
- Main outer fabric: 100% Polyester
Filling: 100% Polyester, Lining: 100% Polyester



Lumbar support prevents sagging and makes mattress much firmer



Sleeping bag attaches to bed via one heavy duty zip



Heavy duty crash zips for easy exit when needed

		*RRP
CBC050	Flatlitter Bed & Bag System MK2 Standard	£369.99
CBC051	Flatlitter Bed & Bag System MK2 Compact	£339.99



Standard Flatlitter

Min height: 40cm, Max height: 50cm, Weight: 13.3kg



Compact Flatlitter

Min height: 35cm, Max height: 45cm, Weight: 12.6kg



Side compression straps enable bed to pack away more compactly with sleeping bag attached



Lumbar support prevents sagging and makes mattress firmer

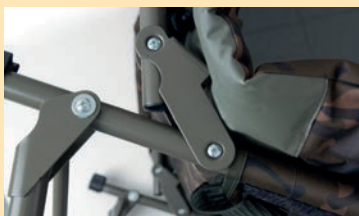

Dual hinge creates space for sleeping bag to be folded up inside



Adjustable legs with large swivel mud feet

R-SERIES CAMO

- Available in three sizes - R1 (Compact), R2 (Standard) and R3 (Kingsize)
- Flat profile for maximum comfort
- Cam-free design for maximum usable width
- Full lumbar support to ensure firm mattress with no sagging
- Fleece-lined, padded mattress
- Features Fox Camo pattern on trim
- Extra padding at head end
- Double hinges allow for a sleeping bag to be folded inside
- Unique side tension straps for ensuring bed is compact when packed away
- Large swivelling mud-feet
- 6 adjustable legs
- Main outer fabric: 100% Polyester
Padding: 100% Polyurethane

		*RRP
CBC054	R1 Camo Bedchair	£149.99
CBC055	R2 Camo Bedchair	£164.99
CBC056	R3 Camo Bedchair	£189.99



Min height: 30cm
Max height: 40cm
Weight: 12.6kg



Min height: 36cm
Max height: 46cm
Weight: 13kg



Min height: 40cm
Max height: 50cm
Weight: 13.8kg

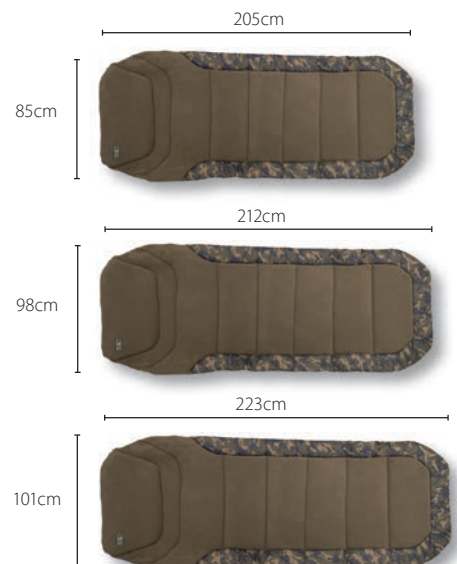



NEW

WARRIOR® II 6 LEG BEDCHAIR

- Entry-level bed that is designed for newcomers and anglers on a tight budget that still want Fox quality
- Offers outstanding value for money
- Cam-free design giving user much more usable width
- Flat frame design with padded, foam mattress for maximum comfort
- Six extendable legs with swivelling mud feet for uneven ground
- Strap and buckle system allows for bed to be packed away compact even with a sleeping bag on
- Weight: 9kg
- Main outer fabric: 100% Polyester
Padding: 100% Polyurethane



Strap and buckle allows compact packaway

WARRIOR® II 6 LEG XL BEDCHAIR

- Larger model of our Warrior 2 6 Leg bedchair
- Lumbar support in head and middle section to make mattress firmer and prevent sagging
- Offers outstanding value for money
- Cam-free design giving user much more usable width
- Flat frame design with padded, foam mattress for maximum comfort
- Six extendable legs with swivelling mud feet for uneven ground
- Strap and buckle system allows for bed to be packed away compact even with a sleeping bag on
- Weight: 13.7kg
- Main outer fabric: 100% Polyester
Padding: 100% Polyurethane



High quality frame



Six extendable legs with swivelling feet

		*RRP
CBC070	Warrior II Six Legged Bedchair	£119.99
CBC071	Warrior II Six Legged XL Bedchair	£139.99

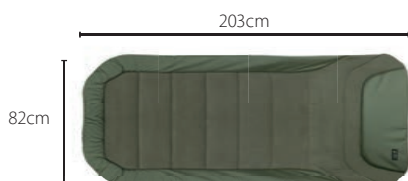

Max height: 40cm
Folded: 82cm x 82cm x 21cm



Max height: 42cm
Folded: 89cm x 100cm x 21cm



*RRP - Recommended retail price

CHAIRS

Dimensions

Height: 40cm
Seat Depth: 38cm
Seat Width: 48cm
Back Height: 53cm



NEW

WARRIOR® II COMPACT CHAIR

- Compact design
- Natural green colours
- Comfortable arm rests
- Padded cover
- Easily foldable
- Adjustable front legs
- Weight: 4.8kg
- Main outer fabric: 100% Polyester
Padding/Filling: 100% Polyurethane

*RRP

CBC067 Warrior II Compact Chair £59.99

Dimensions

Height: 40-51cm
Seat Depth: 41cm
Seat Width: 53cm
Back Height: 64cm



NEW

WARRIOR® II XL ARM CHAIR

- Natural green colours
- Comfortable arm rests
- Padded cover
- Easily foldable
- All four legs are fully adjustable
- Weight: 5.7kg
- Main outer fabric: 100% Polyester
Padding/Filling: 100% Polyurethane

*RRP

CBC069 Warrior II XL Arm Chair £79.99

Dimensions

Height: 40-50cm
Seat Depth: 41cm
Seat Width: 49cm
Back Height: 64cm



NEW

WARRIOR® II ARM CHAIR

- All four legs are fully adjustable
- Natural green colours
- Comfortable arm rests
- Padded cover
- Easily foldable
- Weight: 5.4kg
- Main outer fabric: 100% Polyester
Padding/Filling: 100% Polyurethane

*RRP

CBC068 Warrior II Arm Chair £64.99



R1 CAMO RECLINER CHAIR

- Smallest of the three new R-Series Camo Recliner Chairs
- High density foam mattress with Micro Fleece
- Extra padding in top section of back for added comfort
- Four fully adjustable legs with large swivelling mud feet
- Fox Camo polyester outer trim
- Leg Lock frame for added stability
- Adjustable back settings via Cam wheel
- Hardwearing steel frame
- Seat height: 36-43cm x Width: 53cm x Back height: 53cm
- Folded dimensions: 64cm x 57cm x 20cm
- Weight: 5.5kg
- Main outer fabric: 100% Polyester
Padding/Filling: 100% Polyurethane

*RRP

CBC060 R1 Camo Chair £89.99



R2 CAMO RECLINER CHAIR

- High density foam mattress with Micro Fleece
- Extra padding in top section of back for added comfort
- Four fully adjustable legs with large swivelling mud feet
- Fox Camo polyester outer trim
- Leg Lock frame for added stability
- Adjustable back settings via Cam wheel
- Hardwearing steel frame
- Neoprene covered arm rests for added comfort
- Seat height: 39-47cm x Width: 59cm x Back height: 57cm
- Folded dimensions: 75cm x 70cm x 20cm
- Weight: 7kg
- Main outer fabric: 100% Polyester
Padding/Filling: 100% Polyurethane

*RRP

CBC061 R2 Camo Chair £104.99



R3 CAMO RECLINER CHAIR

- Largest of the three new R-Series Camo Recliner Chairs
- Fox Camo polyester outer trim
- High density foam mattress with Micro Fleece
- Four fully adjustable legs with large swivelling mud feet
- Leg Lock frame for added stability
- Adjustable back settings via Cam wheel
- Hardwearing steel frame
- Neoprene covered arm rests for added comfort
- Full height back with additional padding in the head rest
- Seat height: 44-56cm x Width: 60cm x Back height: 73cm
- Folded dimensions: 84cm x 70cm x 20cm
- Weight: 7.5kg
- Main outer fabric: 100% Polyester
Padding/Filling: 100% Polyurethane

*RRP

CBC062 R3 Camo Chair £129.99





Dimensions

Seat height: 32cm
 Back height: 52cm
 Seat width: 47cm
 Folded: 14 x 54 x 72cm

FX COMBO CHAIR

- Multi-purpose, innovative design that makes it one of the most versatile and comfortable chairs on the market
- Three uses in one!
- Use 1: Positioned across bedchair like a traditional bedchair buddy
- Use 2: Positioned on side of bedchair frame for sitting at front of bivvy
- Use 3: Independent of a bedchair as a standalone low-chair
- Adjustable back leg
- Fully adjustable 'Twist-Lok' front legs
- Same fleece lined, high density foam padding as used on award-winning FX Flatliner bedchairs
- Padded head rest for extra comfort
- Retaining straps keep chair closed when being carried
- Removable, padded shoulder strap supplied for easy transportation
- Weight: 5.5kg
- Main outer fabric: 100% Polyester, Padding/Filling: 100% Polyurethane

*RRP

CBC042 FX Combo Chair

£94.99



Dimensions

Seat height: 45-60cm
 Back height: 70cm
 Seat width: 60cm
 Folded: 21 x 71 x 83cm

FX SUPER DELUXE RECLINER

- Quite possibly the most comfortable and feature-filled chair ever designed for fishing
- Full height back featuring unique deluxe head support for ultimate comfort
- Cam Lok recliner allowing you to set the seating position that best suits your mood
- High density ribbed foam mattress with micro fleece
- Fabric inner and luxury faux suede perimeter as used on Flatliner bedchair and FX Combo Chair
- Neoprene covered arm rests for extra comfort
- Four adjustable 'Twist Lok' legs with swivelling mud feet to allow ultimate comfort when on uneven ground
- Steel frame for strong build quality and to accommodate the 'larger' angler
- Main outer fabric: 100% Polyester, Padding/Filling: 100% Polyurethane

*RRP

CBC047 FX Super Deluxe Recliner

£169.99



DURALITE® CHAIR

- Strong but exceptionally lightweight Duralite Magnesium Alloy construction
- 3D mesh and polyester padded seat aids comfort whilst helping to keep overall weight low
- Fully adjustable legs that lock into position
- Arm rests for added comfort
- Large swivelling mud feet
- Rated to 180kg
- Height: 33 - 40cm
- Seat: 40cm deep
- Back height: 52cm
- Seat width: 47cm
- Weighs just 3.2kg
- Main outer fabric: 100% Polyester
 Padding/Filling: 100% Polyurethane

*RRP

CBC059 Duralite Chair

£89.99



ADJUSTA LEVEL CHAIR

- Reinforced frame construction (weight rating 160kg)
- Lightweight yet very strong
- Hardwearing 600 Denier Polyester fabric
- Increased padding for greater comfort
- Extra padding around frame also
- Tension straps allow you to fasten chair closed during transport, which also makes it handy for storing items such as banksticks etc when on the move
- Unique design allows for multiple height settings
- Padded, removable carry strap that leaves both of your hands free to carry other tackle items
- Outer main fabric: 100% Polyester
 Padding: 100% Polyurethane

*RRP

CBC040 Adjusta Level Chair

£64.99



NEW

Chair not included

WATERPROOF CHAIR COVERS

- Waterproof cover designed to keep your chair dry when left outside bivvy in rain/heavy dew
- 2000mm hydrostatic head
- Fully taped seams
- Khaki colour
- Elasticated for secure fit
- Supplied with carry bag
- Two sizes available: Standard to fit small/medium chairs and XL for larger recliner-style chairs

*RRP

CBC063 Waterproof Chair Cover - Standard

£13.99

CBC064 Waterproof Chair Cover - XL

£14.99

VRS1



VRS2



VRS3



Waterproof Ven-Tec Rip Stop outer fabric

VRS SLEEPING BAG

- Based on original Evo Ven-Tec All Season sleeping bag but with significant upgrades
- Features the new waterproof Ven-Tec Rip Stop outer fabric
- Utilises 7 Core Hollow Fibre filling, which is silicone treated to help maintain shape and expand fibres
- Comprises a total of four layers for unrivalled warmth even in the coldest of conditions
- Contains a removable thermal booster bag, which is micro fleece lined on all sides and packed with 7 core hollow fibre fill
- Base and upper layer also packed with top quality 7 core hollow fibre fill
- Polyester lined base layer
- Micro fleece lining gives incredible warmth and comfort
- Offset panel stitching helps to keep warm air inside the bag
- 10mm heavy-duty crash zips that don't snag when you need to exit the bag in a hurry
- Oversized external zip baffles help to keep cold air out and warm air in
- Oversized internal baffles packed with hollow fill to keep warm air in bag prevent it escaping through zips
- Elasticated hoods at head and foot end plus elasticated strap in middle to help secure bag to bedchair
- Zipped mesh pockets on both sides are perfect for storing valuable items such as receiver, keys, phone and wallet
- Pillow retaining hood helps to stop your pillow from sliding off the bed
- Hot foot pocket – zips stop short at the foot end to create a thermal pocket around your feet
- Supplied in stuff sack
- Available in three sizes VRS1 (ideal for compact bedchairs such as R1 Camo), VRS2 (designed for standard sized bedchairs such as Flatliner and R2 Camo) and VRS3 (designed for larger beds such as Kingsize Flatliner and R3 Camo)
- Main outer fabric: 100% Polyester
Padding/Filling: 100% Polyester, Lining: 100% Polyester

		*RRP
CSB037	VRS1 Sleeping Bag	£189.99
CSB038	VRS2 Sleeping Bag	£199.99
CSB039	VRS3 Sleeping Bag	£219.99



ERS SLEEPING BAG

- Features new hardwearing Evo-Tec Rip Stop outer fabric
- Utilises 7 Core Hollow Fibre filling which is silicone treated to help maintain shape and expand fibres
- Polyester lined base for ease of movement inside the bag
- Micro fleece lined upper layer for added warmth and comfort
- Offset panel stitching helps to keep warm air inside the bag
- 10mm heavy-duty crash zips that don't snag when you need to exit the bag in a hurry
- Oversized external zip baffles help to keep cold air out and warm air in
- Oversized internal baffles packed with hollow fill to keep warm air in bag prevent it escaping through zips
- Elasticated hoods at head and foot end plus elasticated strap in middle to help secure bag to bedchair
- Zipped mesh pockets on both sides are perfect for storing valuable items such as receiver, keys, phone and wallet
- Pillow retaining hood helps to stop your pillow from sliding off the bed
- Hot foot pocket – zips stop short at the foot end to create a thermal pocket around your feet
- Supplied in stuff sack
- Available in three sizes ERS1 (ideal for compact bedchairs such as R1 Camo), ERS2 (designed for standard sized bedchairs such as Flatliner and R2 Camo) and ERS3 (designed for larger beds such as Kingsize Flatliner and R3 Camo)
- Main outer fabric: 100% Polyester
Padding/Filling: 100% Polyester, Lining: 100% Polyester

		*RRP
CSB034	ERS1 Sleeping Bag	£94.99
CSB035	ERS2 Sleeping Bag	£104.99
CSB036	ERS3 Sleeping Bag	£109.99

ERS1



ERS2

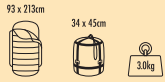

ERS3



NEW

ERS FULL FLEECE SLEEPING BAGS

- Based on same design as original ERS sleeping bags but with full fleece inner lining for added warmth and comfort
 - Sherpa fleece-lined internal upper layer
 - Micro fleece-lined internal base layer
 - Seven Core Hollow Fibre filling, which is silicone treated to help maintain shape and expand fibres
 - Offset panelling helps to keep warm air trapped inside bag
 - 10mm heavy-duty crash zips
 - Rip Stop outer material
 - Mesh side pockets for handy storage
 - Pillow retaining hood helps to prevent pillow from sliding off the bed
 - Oversized internal and external zip baffles to help keep heat in and cold out
 - Elasticated hoods at head and foot ends for securing to bedchair
 - Elasticated securing strap for firm fixing to bedchair
 - Supplied in stuff sack
- Available in three sizes: ERS Full Fleece 1 (ideal for compact bedchairs such as R1 Camo), ERS Full Fleece 2 (ideal for standard sized bedchairs such as Flatliner or R2 Camo) and ERS Full Fleece 3 (designed for larger bedchairs such as Flatliner Kingsize and R3 Camo)
 - Main outer fabric: 100% Polyester
Padding/Filling: 100% Polyester
Lining: 100% Polyester

*RRP

CSB049	ERS1 Full Fleece Sleeping Bag	£104.99
CSB050	ERS2 Full Fleece Sleeping Bag	£114.99
CSB051	ERS3 Full Fleece Sleeping Bag	£124.99





ERS1
FULL FLEECE LINING

88 x 210cm 37 x 48cm 3.3kg



ERS2
FULL FLEECE LINING

93 x 213cm 40 x 48cm 3.5kg



ERS3
FULL FLEECE LINING

103 x 220cm 43 x 50cm 4.2kg





WARRIOR® SLEEPING BAG

- Designed for newcomers and anglers on a tight budget that still want Fox quality
 - Perfect for use with the Warrior bedchair
 - Offset panel stitching helps to keep warm air inside the bag
 - 2-3 season rating - perfect for use in late spring, summer and early autumn
 - 10mm crash zips
 - Soft Touch Polyester fabric
 - Polyester lining for easy movement inside the bag
 - Oversized internal and external baffles to keep warm air in and cold air out
- Elasticated hoods at head and foot end plus elasticated strap in middle to help secure bag to bedchair
 - Comes supplied in stuff sack
 - Offers outstanding value for money
 - Main outer fabric: 100% Polyester
Padding/Filling: 100% Polyester
Lining: 100% Polyester

*RRP

CSB043	Warrior Sleeping Bag	£59.99
--------	----------------------	--------





FOX
WARRIOR
SLEEPING BAG

88 x 210cm 40 x 50cm 2.4kg





VRS SLEEPING BAG COVER



Waterproof Ven-Tec Rip Stop outer fabric



- Waterproof and hardwearing Ven-Tec Rip Stop outer fabric
- Micro fleece lined inner
- Elasticated hood at foot end to secure on bed
- Retaining quick release buckle side straps
- Velcro strips on both sides for attaching to underside of R-Series Camo or Flatlitter MK2 beds
- Ideal for adding to ERS sleeping bag to give waterproof cover and additional warmth
- Available in three sizes: VRS1 (ideal for compact bedchairs such as R1 Camo), VRS2 (designed for standard sized bedchairs such as the Flatlitter and R2 Camo) and VRS3 (designed for larger beds such as Kingsize Flatlitter and R3 Camo)

- Supplied in stuff sack
- Main outer fabric: 100% Polyester
- Padding/Filling: 100% Polyester
- Lining: 100% Polyester

		*RRP
CSB040	VRS1 Sleeping Bag Cover	£59.99
CSB041	VRS2 Sleeping Bag Cover	£69.99
CSB042	VRS3 Sleeping Bag Cover	£79.99

FLATLITER[®] MKII

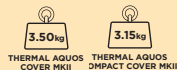

FLATLITER[®] MK2 AQUOS[®] COVER

- Lightweight with soft-touch fleece lining for additional warmth
- Waterproof outer
- Features unique Fox camo pattern
- Oversized to ensure whole sleeping bag remains covered even when someone is inside the bag
- Strap at foot end attaches to single leg on bed
- Velcro strips on both sides allow attachment to underside of Flatlitter MK2 bed for side you won't exit

- Available for both Compact and Standard Flatlitter MK2
- Can fold up inside bed whilst attached
- Can also be used in conjunction with ERS sleeping bags
- Main outer fabric: 100% Polyester
- Filling: 100% Polyester
- Lining: 100% Polyester

		*RRP
CSB030	Flatlitter MK2 Aquos Cover Standard	£64.99
CSB031	Flatlitter MK2 Aquos Cover Compact	£54.99

FLATLITER[®] MK2 AQUOS[®] THERMAL COVER

- Thick layer of insulation with soft-touch fleece lining for lots of extra warmth
- Converts standard Flatlitter MK2 sleeping bag into a 5 season option
- Perfect for use in the winter months
- Waterproof outer
- Features unique Fox Camo pattern
- Oversized to ensure whole sleeping bag remains covered even when someone is inside the bag
- Velcro strips on both sides allow attachment to underside of Flatlitter MK2 bed for side you won't exit

- Strap at foot end attaches to single leg on bed
- Available for both Compact and Standard Flatlitter MK2
- Can fold up inside bed whilst attached
- Can also be used on own as a blanket for warmer months when no need for a full sleeping bag
- Can also be used in conjunction with ERS sleeping bags
- Main outer fabric: 100% Polyester, Filling: 100% Polyester, Lining: 100% Polyester

		*RRP
CSB032	Flatlitter MK2 Thermal Aquos Cover Standard	£99.99
CSB033	Flatlitter MK2 Thermal Aquos Cover Compact	£89.99

FLATLITER® MK2 5 SEASON BAG

- Optional 5 Season bag for the Flatliter MK2 during winter months
- Attaches to Flatliter MK2 via heavy duty zip around perimeter of mattress – simply unzip standard bag and replace with 5 Season in a matter of seconds
- Super-soft filling that is not only extremely warm but also sculpts around your body for increased comfort
- Can be folded inside MK2 Flatliter at end of session

- Main outer fabric: 100% Polyester
Filling: 100% Polyester, Lining: 100% Polyester
- Available in two sizes: Standard and Compact

*RRP		
CSB028	Flatliter MK2 5 Season Bag Standard	£149.99
CSB029	Flatliter MK2 5 Season Bag Compact	£139.99

FLATLITER MKII

5 SEASON **5.20kg**
5 SEASON MKII

5 SEASON **4.90kg**
5 SEASON COMPACT MKII



ROYALE® SLEEPING BAG CARRYALL

- Available in two sizes – Standard and XL (for VRS3 and ERS3 Sleeping Bags)
- Perfect for transporting your sleeping bag to and from a venue
- Reinforced, waterproof base
- 10mm heavy-duty zips
- Stiffened EVA handles
- Reinforced tension straps for tight compression

*RRP		
CLU259	Sleeping Bag Carryall Standard	£27.99
CLU260	Sleeping Bag Carryall X Large	£32.99



NEW

CAMOLITE™ PILLOWS

- Dual sided
- Micro fleece on one side to keep you warm in winter
- Soft cotton on the other side to keep you cool in summer
- Removable cover can be cleaned
- Two sizes available: Standard and XL

*RRP		
CLU314	Camolite Standard Pillow	£17.99
CLU315	Camolite XL Pillow	£22.99



NEW

CAMOLITE™ HOT WATER BOTTLE

- Fleece and cotton combo
- Unique Fox Camo pattern
- Neoprene lined to retain heat for longer
- Water bottle supplied

*RRP		
CLU316	Camolite Hot Water Bottle	£14.99





LUGGAGE & BARROWS

Being market leaders in the carp luggage range means we have a certain amount of pressure to ensure we always stay one step ahead of our competition and offer our customers the best luggage possible.

Following seven years in our catalogue we have taken the decision to replace our top-end FX models with a brand-new Voyager range. As we now have access to higher quality materials and some fresh new designs to offer our customers greater value for money than ever before! The initial launch of Voyager features 25 products and we are sure as the range grows in popularity so will the number of products too. In addition to the new Voyager range, both the Royale and Camolite offerings remain for 2018 with a number of new additions being added to Camolite such is the amazing demand for this uniquely-styled range.

So you have three very detailed ranges, with varying prices, features and styling to select from, meaning that whatever your needs and wants, you are sure to find the luggage items required over the coming pages. In addition to the luggage ranges you will also find our offering of carp barrows over the coming pages. New for 2018 is the Explorer Deluxe barrow, which benefits from a number of design tweaks compared to the original Explorer...



Handy storage pockets on all 12ft and 13ft Rod Cases



Padded protection at both ends of rod



3+3 models hold up to 6 made up rods



NEW

VOYAGER® 13FT 3+3 ROD CASE

- Unique design to maximise rod and reel storage space
- Designed to accommodate up to six made up 13ft rods with reels
- Will comfortably fit 50mm K-Series guides and large, big pit reels such as FX13
- Sculpted fit to reduce bulk
- Reinforced PU board in all key areas including reel and guide sections
- Rods fit into the case with the reel and guides facing downwards
- Rod butt end slots into the padded hoods at each end whilst the tip end is secured in place by Velcro strap
- Three internal padded dividers – two rods fit into each section with (one rod pointing up and one rod pointing down)
- Three external storage pockets for holding items such as spods, marker floats, leads and essential rig bits
- Large external pocket with full length zip for storing landing net, banksticks and marker sticks
- Stiffened EVA grab handles
- 10mm heavy duty double zips
- New Hydratec water-resistant fabric (100% treated 1050 denier polyester)
- Dimensions: H 214cm x W 37cm x D 21cm

*RRP

CLU330 Voyager 13ft 3+3 Rod Case

£159.99



NEW

VOYAGER® 12FT 3+3 ROD CASE

- Unique design to maximise rod and reel storage space
- Designed to accommodate up to six made up 12ft rods with reels
- Will comfortably fit 50mm K-Series guides and large, big pit reels such as FX13
- Sculpted fit to reduce bulk
- Reinforced PU board in all key areas including reel and guide sections
- Rods fit into the case with the reel and guides facing downwards
- Rod butt end slots into the padded hoods at each end whilst the tip end is secured in place by Velcro strap
- Three internal padded dividers – two rods fit into each section with (one rod pointing up and one rod pointing down)
- Three external storage pockets for holding items such as spods, marker floats, leads and essential rig bits
- Large external pocket with full length zip for storing landing net, banksticks and marker sticks
- Stiffened EVA grab handles
- 10mm heavy duty double zips
- New Hydratec water-resistant fabric (100% treated 1050 denier polyester)
- Dimensions: H 197cm x W 37cm x D 21cm

*RRP

CLU329 Voyager 12ft 3+3 Rod Case

£149.99





Heavy-duty 10mm zips



Reversible shoulder straps



2+2 models hold up to 4 made up rods



NEW

VOYAGER® 13FT 2+2 ROD CASE

- Unique design to maximise rod and reel storage space
- Designed to accommodate up to four made up 13ft rods with reels
- Will comfortably fit 50mm K-Series guides and large, big pit reels such as FX13
- Sculpted fit to reduce bulk
- Reinforced PU board in all key areas including reel and guide sections
- Rods fit into the case with the reel and guides facing downwards
- Rod butt end slots into the padded hoods at each end whilst the tip end is secured in place by Velcro strap
- Two internal padded dividers – two rods fit into each section with (one rod pointing up and one rod pointing down)
- Three external storage pockets for holding items such as spods, marker floats, leads and essential rig bits
- Large external pocket with full length zip for storing landing net, banksticks and marker sticks
- Stiffened EVA grab handles
- 10mm heavy duty double zips
- New Hydratec water-resistant fabric (100% treated 1050 denier polyester)
- Dimensions: H 214cm x W 25cm x D 21cm

*RRP

CLU328 Voyager13ft 2+2 Rod Case £139.99

NEW

VOYAGER® 12FT 2+2 ROD CASE

- Unique design to maximise rod and reel storage space
- Designed to accommodate up to four made up 12ft rods with reels
- Will comfortably fit 50mm K-Series guides and large, big pit reels such as FX13
- Sculpted fit to reduce bulk
- Reinforced PU board in all key areas including reel and guide sections
- Rods fit into the case with the reel and guides facing downwards
- Rod butt end slots into the padded hoods at each end whilst the tip end is secured in place by Velcro strap
- Two internal padded dividers – two rods fit into each section with (one rod pointing up and one rod pointing down)
- Three external storage pockets for holding items such as spods, marker floats, leads and essential rig bits
- Large external pocket with full length zip for storing landing net, banksticks and marker sticks
- Stiffened EVA grab handles
- 10mm heavy duty double zips
- New Hydratec water-resistant fabric (100% treated 1050 denier polyester)
- Dimensions: H 197cm x W 25cm x D 21cm

*RRP

CLU327 Voyager12ft 2+2 Rod Case £129.99



New Hydratec fabric



EVA grab handle



NEW

VOYAGER® 10FT 2+2 ROD CASE

- Unique design to maximise rod and reel storage space
- Designed to accommodate up to four made up 10ft rods with reels
- Will comfortably fit 50mm K-Series guides and large, big pit reels such as FX13
- Sculpted fit to reduce bulk
- Reinforced PU board in all key areas including reel and guide sections
- Rods fit into the case with the reel and guides facing downwards
- Rod butt end slots into the padded hoods at each end whilst the tip end is secured in place by Velcro strap and then protected by a Velcro-secured flap
- Two internal padded dividers – two rods fit into each section with (one rod pointing up and one rod pointing down)
- Large external pocket with full length zip for storing landing net, banksticks and marker sticks
- Stiffened EVA grab handles
- 10mm heavy duty double zips
- New Hydratec water-resistant fabric (100% treated 1050 denier polyester)
- Dimensions: H 166cm x W 25cm x D 21cm



Tri Sleeve takes up to three made up rods



10mm heavy duty zips



NEW

VOYAGER® TRI SLEEVE 12FT

- Designed to store three made-up rods
- Sculpted to accommodate big pit reels, 50mm butt rings and K-Series guides
- Padded internal dividers
- Reinforced base
- External storage pockets for leads and rig bits
- 10mm heavy duty double zips
- Stiffened EVA grab handles
- Reversible, padded shoulder strap
- New Hydratec water-resistant fabric (100% treated 1050 denier polyester)
- Dimensions: H 192cm x W 38cm

*RRP

CLU331 Voyager10ft 2+2 Rod Case

£89.99

*RRP

CLU332 Voyager Tri Sleeve 12ft

£99.99





Single Rod Jackets accommodate largest of reels



Padded, reversible shoulder straps

NEW

**VOYAGER®
ROD SLEEVE 10FT, 12FT, 13FT**

- Available in 10ft, 12ft and 13ft
- Designed to store one made-up rod
- Sculpted to accommodate big pit reels, 50mm butt rings and K-Series guides
- 10mm heavy duty double zips
- Stiffened EVA grab handles
- New Hydratec water-resistant fabric (100% treated 1050 denier polyester)
- Dimensions:
10ft: H 168cm x W 24cm
12ft: H 198cm x W 24cm
13ft: H 210cm x W 24cm

		*RRP
CLU333	Voyager Rod Sleeve 10ft	£31.99
CLU334	Voyager Rod Sleeve 12ft	£34.99
CLU335	Voyager Rod Sleeve 13ft	£36.99

NEW

**VOYAGER®
BROLLY CARRYALL**

- Ideal for use with Royale and Ultra Brolly ranges
- Voyager Tri Sleeve and Single Jackets can fit in outside pocket and strap to outside of carryall
- Moulded base and top
- 10mm heavy duty double zips
- Stiffened EVA grab handles
- Reversible, padded shoulder strap
- New Hydratec water-resistant fabric (100% treated 1050 denier polyester)
- Dimensions: H 197cm x W 20cm

		*RRP
CLU336	Voyager Brolly Carryall	£44.99



Many items feature moulded bases



Heavy-duty buckles and clips



Compact Barrow Bag works with Explorer Barrow



Ruckall can carry a chair



Contents not included

VOYAGER® BARROW BAG

NEW

- Designed to fit most barrows on the market maximising storage space both in your swim and in transit
- Massive main compartment capacity
- Four exterior pockets: 2 x front pockets (biggest one holds large double F Box, smaller one ideal for accessory bags), 2 x side pockets ideal for tackle essentials
- Side pockets each have external Velcro-fastened meshed pouches
- Moulded base and lid
- PU boards inside give a totally rigid body
- EVA grab handles on both sides for easy lifting and loading
- Removable, padded 3D shoulder strap
- Three zipped mesh pockets inside lid provide extra storage room
- 10mm heavy duty double zips
- New Hydratec water-resistant fabric (100% treated 1050 denier polyester)
- Dimensions: H 39cm x W 79cm x D 49cm



CLU338 Voyager Barrow Bag

*RRP
£129.99

VOYAGER® COMPACT BARROW BAG

NEW

- Perfect for storing tackle, bait and clothing
- Adjustable internal divider for keeping tackle box separate to main compartment but maintaining quick access via gusseted front hatch
- Perfect for use with Explorer and Explorer Deluxe barrows
- Adjustable retaining panel on rear with Velcro fastening to make attaching to front bar of both Explorer barrow models very easy
- Stiffened EVA grab handles
- Removable, padded 3D shoulder strap
- External and internal mesh pockets
- Two external zipped pockets for extra storage
- Reinforced base and lid
- 10mm heavy duty double zips
- New Hydratec water-resistant fabric (100% treated 1050 denier polyester)
- Dimensions: H 35cm x W 57cm x D 31cm



CLU340 Voyager Compact Barrow Bag

*RRP
£84.99

VOYAGER® RUCKALL

NEW

- Unique design that combines the benefits of a rucksack and carryall in one
- Padded, 3D non-slip shoulder straps and a padded back section make Ruckall very comfortable to carry
- Padded back becomes lid when Ruckall is placed on the ground
- Reinforced moulded base
- One side features a full length external storage pocket whilst the other features two smaller external storage pockets – all of which are perfect for storing a variety of accessories
- Two removable straps allow a chair and/or unhooking mat to be attached to the Ruckall for hands-free carrying
- Elasticated pocket inside lid for storage of tackle box
- Low profile allows for easy storage under your bedchair
- High quality heavy duty double zips
- New Hydratec water-resistant fabric (100% treated 1050 denier polyester)
- Dimensions: H 35cm x W 57cm x D 31cm



CLU343 Voyager Ruckall

*RRP
£84.99



VOYAGER® LARGE CARRYALL

NEW

- Designed to house all of your essential tackle items such as tackle box, weighing scales, head torch, PVA, hookbaits, spare clothes, baiting tools etc
- Moulded base
- Four external pockets; 2 x side pockets, pocket on lid plus front pocket (will hold large double F Box)
- Side pockets each have external Velcro-fastened meshed pouches
- 10mm heavy duty double zips
- Stiffened EVA grab handles

- Removable, padded 3D shoulder strap
- New Hydratec water-resistant fabric (100% treated 1050 denier polyester)
- Dimensions: H 43.5cm x W 64cm x D 40cm

CLU337 Voyager Large Carryall

*RRP

£79.99



VOYAGER® LOW LEVEL CARRYALL

NEW

- Low profile carryall that can be stored under your bedchair
- Designed to work in conjunction with Explorer and Deluxe Explorer barrows
- Adjustable retaining panel on rear with Velcro fastening to make attaching to front bar of both Explorer barrow models very easy
- Two external side storage pockets – ideal for accessories such as PVA etc
- Zipped mesh storage pockets on outside side pockets
- Top pocket designed for storage of large Fox tackle box
- Main compartment perfect for storing host of tackle items including smaller accessory bags
- Reinforced moulded base

- EVA grab handles
- Removable, padded 3D shoulder strap
- 10mm heavy duty double zips
- New Hydratec water-resistant fabric (100% treated 1050 denier polyester)
- Dimensions: H 26cm x W 54cm x D 29cm

CLU341 Voyager Low Level Carryall

*RRP

£64.99



VOYAGER® 2 MAN COOLER

NEW

- Perfect for storing food and helping to keep it fresh
- Supplied with 2 x square plates, 2 x ceramic mugs, 2 x knives, 2 x forks, 2 x tablespoons, 1 x teaspoon, 1 x corkscrew/bottle opener, 1 x chopping board, 4 x storage pots (2 x large and 2 x small) all of which are stored in the lid section
- Thermally lined, wipe clean main compartment with a thermal zip baffle to prevent heat loss
- Two thermally lined side pockets with thermal zip baffles
- Moulded base and lid

- EVA grab handles
- Removable, padded 3D shoulder strap
- 10mm heavy duty double zips
- New Hydratec water-resistant fabric (100% treated 1050 denier polyester)
- Dimensions: H 46cm x W 55cm x D 32cm

CLU339 Voyager 2 Man Cooler

*RRP

£129.99



VOYAGER® BED BAG

NEW

- Designed to fit all sizes of Fox bedchair and most others on the market
- Roll down top with fastening buckles allows bag to fit various sizes of bedchair
- ¾ length zips make it easy to insert and take out bedchairs
- EVA grab handles
- Removable, padded 3D shoulder strap
- 10mm heavy duty double zips
- New Hydratec water-resistant fabric (100% treated 1050 denier polyester)

CLU345 Voyager Bed Bag

*RRP

£59.99



Water-resistant Hydratec fabric



Low Level bags fit under bedchair



Large Cooler is insulated and features divider



Cooler Bag features insulated lining



Contents not included

VOYAGER® LOW LEVEL COOLER

NEW

- Low profile insulated carryall that can be stored under your bedchair
- Designed to work in conjunction with Explorer and Deluxe Explorer barrows
- Adjustable retaining panel on rear with Velcro fastening to make attaching to front bar of both Explorer barrow models very easy
- Will also fit perfectly inside the central Under Barrow Bag on the Explorer and Explorer Deluxe barrows
- Insulated with 2 x removable/adjustable dividers – perfect for storing bait and/or food and keeping it fresh
- Front and side handles makes it easy to remove from central Under Barrow Bag on Explorer barrows and from underneath your bedchair
- Reinforced moulded base
- EVA grab handles
- Removable, padded 3D shoulder strap
- 10mm heavy duty double zips
- New Hydratec water-resistant fabric (100% treated 1050 denier polyester)
- Dimensions: H 15cm x W 54cm x D 29cm



*RRP

CLU342 Voyager Low Level Cooler

£74.99

VOYAGER® LARGE COOLER

NEW

- Features top quality thermal lining
- Ideal for storing items such as bait and food that need to be kept fresh
- Removable internal divider
- Internal mesh storage pocket
- Designed to fit perfectly inside the central Under Barrow Bag on the Explorer Barrow and Explorer Deluxe barrow (with shelf removed)
- Side handle makes it easy to remove from central Under Barrow Bag on Explorer barrows and from underneath your bedchair
- 10mm heavy duty double zips
- New Hydratec water-resistant fabric (100% treated 1050 denier polyester)
- Dimensions: H 30cm x W 40cm x D 20cm



*RRP

CLU326 Voyager Large Cooler

£34.99

VOYAGER® COOLER BAG

NEW

- Features top quality thermal lining
- Ideal for storing items such as bait and food that need to be kept fresh
- Designed to fit perfectly inside the central Under Barrow Bag on the Explorer and Explorer Deluxe barrows
- Side handle makes it easy to remove from central Under Barrow Bag on Explorer barrows and from underneath your bedchair
- 10mm heavy duty double zips
- New Hydratec water-resistant fabric (100% treated 1050 denier polyester)
- Dimensions: H 15cm x W 39cm x D 18cm



*RRP

CLU325 Voyager Cooler Bag

£24.99

VOYAGER® STORAGE BAG

NEW

- Ideal for storing items such as stove, gas canisters and cookware
- Designed to fit perfectly inside the central Under Barrow Bag on the Explorer and Explorer Deluxe barrows
- Side handle makes it easy to remove from central Under Barrow Bag on Explorer barrows and from underneath your bedchair

- 10mm heavy duty double zips
- New Hydratec water-resistant fabric (100% treated 1050 denier polyester)
- Dimensions: H 15cm x W 39cm x D 18cm

*RRP

CLU324 Voyager Storage Bag

£19.99





Contents not included

NEW

VOYAGER® GADGETS SAFE

- Unique design for storing 'gadget' items such as small power packs, iPad, chargers, head torch etc
- Access port on side for easy access to power pack for charging phones, head torch etc
- Mesh side pocket on top for holding phone when being charged
- High quality heavy duty double zips
- EVA grab handle
- New Hydratec water-resistant fabric (100% treated 1050 denier polyester)
- Dimensions: H 9cm x W 30cm x D 23cm

CLU344 Voyager Gadgets Safe *RRP
£24.99



VOYAGER® CERAMIC MUG

NEW

- Ceramic mug for hot drinks
- Features unique carp scale print



CLU349 Ceramic Scales Mug *RRP
£4.99



NEW

Contents not included

NEW

Contents not included

NEW

Contents not included

VOYAGER® ACCESSORY BAG SMALL

- Ideal for storing essential items such as a rig bits, leads, lighters and head torch
- Tinted clear lid
- Polyester webbing grab handle
- 10mm heavy duty zip
- New Hydratec water-resistant fabric (100% treated 1050 denier polyester)
- Dimensions: H 9cm x W 13cm x D 8cm

CLU346 Voyager Accessory Bag S *RRP
£8.99

VOYAGER® ACCESSORY BAG MEDIUM

- Ideal for storing essential items such as a rig bits, leads, scissors, PVA bags, lighters and head torch
- Tinted clear lid
- Polyester webbing grab handle
- 10mm heavy duty zip
- New Hydratec water-resistant fabric (100% treated 1050 denier polyester)
- Dimensions: H 9cm x W 16cm x D 13cm

CLU347 Voyager Accessory Bag M *RRP
£11.99

VOYAGER® ACCESSORY BAG LARGE

- Ideal for storing essential items such as PVA dispensers, Impact Spods, rig bits, leads, Zig Floats, lighters and head torch
- Tinted clear lid
- Polyester webbing grab handle
- 10mm heavy duty double zips
- New Hydratec water-resistant fabric (100% treated 1050 denier polyester)
- Dimensions: H 10cm x W 27cm x D 17cm

CLU348 Voyager Accessory Bag L *RRP
£13.99



Features unique Fox Camo pattern



Handy storage pockets on Rod Holdall and Tri Sleeve



Stiffened EVA grab handles



Reversible shoulder straps



CAMOLITE™ 3 UP 2 DOWN ROD HOLDALL

- Based on same award-winning design from FX luggage range
- Takes five made-up rods in total – three in one direction and two in the other
- Sculpted to accommodate big pit reels and 50mm butt rings
- Padded internal dividers
- External storage pockets for leads and rig bits
- Reinforced base
- 10mm Heavy Duty double zips
- Stiffened EVA grab handles
- Reversible, padded shoulder strap
- 100% treated 500 denier polyester material
- Styled in unique Fox Camo pattern
- Main outer fabric: 100% Polyester
Lining: 100% Polyester
Padding/Filling: 70% Polyethylene 30% Polyurethane
- Dimensions: H 198cm x W 40cm x D 30cm

CAMOLITE™ TRI-SLEEVE

- Available in three sizes – 10ft, 12ft and new 13ft option
- Designed to store three made-up rods
- Sculpted to accommodate big pit reels and 50mm butt rings
- Padded internal dividers
- Reinforced base
- External storage pockets for leads and rig bits
- 10mm Heavy Duty double zips
- Stiffened EVA grab handles
- Reversible, padded shoulder strap
- 100% treated 500 denier polyester material
- Styled in unique Fox Camo pattern
- Main outer fabric: 100% Polyester
Lining: 100% Polyester
Padding/Filling: 60% Polyethylene and 40% Polyurethane
- Dimensions:
10ft: H 165cm x W 38cm x D 30cm
12ft: H 192cm x W 38cm x D 30cm
13ft: H 208cm x W 38cm x D 30cm

		*RRP
CLU288	Camolite 3 up 2 Down 12ft	£149.99

		*RRP
CLU286	Camolite Tri-Sleeve 10ft	£94.99
CLU287	Camolite Tri-Sleeve 12ft	£119.99
CLU297	Camolite Tri-Sleeve 13ft	NEW £134.99



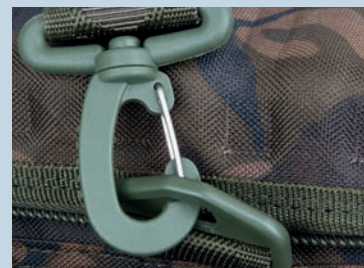

Top quality buckles and clips



Heavy Duty zips

CAMOLITE™ SINGLE ROD JACKETS

- Available in 10ft, 12ft and 13ft
- Designed to store one made-up rod
- Sculpted to accommodate big pit reels and 50mm butt rings
- 10mm Heavy Duty double zips
- Stiffened EVA grab handles
- 100% treated 500 denier polyester material
- Styled in unique Fox Camo pattern
- Main outer fabric: 100% Polyester
Lining: 100% Polyester
Padding/Filling: 100% Polyurethane
- Dimensions:
10ft: H 168cm x W 24cm
12ft: H 198cm x W 24cm
13ft: H 210cm x W 24cm

CAMOLITE™ BROLLY CARRYALL

- Ideal for use with Royale and Ultra 60 brolly ranges
- Camolite Tri Sleeve, 3 Up 2 Down or Single Jackets can fit in outside pocket and strap to outside of carryall
- Moulded base and top
- 10mm Heavy Duty double zips
- Stiffened EVA grab handles
- Reversible, padded shoulder strap
- 100% treated 500 denier polyester material
- Styled in unique Fox Camo pattern
- Main outer fabric: 100% Polyester
Lining: 100% Polyester
Padding/Filling: 100% Polyethylene
Base: 100% Ethylene Vinyl Acetate Copo (EVA)
- Dimensions: H 178cm x W 22cm x D 25cm

		*RRP
CLU290	Camolite Single Rod Jacket 10ft	£32.99
CLU291	Camolite Single Rod Jacket 12ft	£34.99
CLU292	Camolite Single Rod Jacket 13ft	£36.99

		*RRP
CLU289	Camolite Brolly Carryall	£59.99

FOX CAMOLITE

NEW

CAMOLITE™ ROD & REEL PROTECTOR

- Unique Fox Camo pattern
- Quilted padding to protect your reels in transit
- Rod tip protectors are joined by Heavy Duty elastic to fit all rods from 10ft to 13ft
- Zipped lead pocket
- 100% treated 500 denier polyester

*RRP

CLU320 Rod & Reel Protector £21.99

Rod not included

NEW

CAMOLITE™ XL TIP PROTECTOR

- Unique Fox Camo pattern
- Solid end to protect rod tips
- Top 8cm contains reinforced padding
- Velcro securing strap fits under the butt eye
- Extra-long to accommodate most butt eye positioning
- 100% treated 500 denier polyester

*RRP

CLU309 Camolite XL Tip Protector £8.99

CAMOLITE™ BUZZ BAR BAG

- One side is designed to store most 3-rod buzz bars with alarms and back rests attached
- Other side houses two internal zipped pockets that are perfect for storing bite indicators, snag ears, receiver etc
- Padded central divider offers protection to buzz bars and alarms in transit
- 100% treated 5000 denier polyester material
- High quality Heavy Duty double zips
- Styled in unique Fox Camo pattern
- Main outer fabric: 100% Polyester
Lining: 100% Polyester
Padding/Filling: 100% Polyethylene

*RRP

CLU300 Camo Buzz Bar Bag £24.99



CAMOLITE™ BOILIE BUM BAGS

- Unique Fox Camo pattern
- Double Heavy Duty zips
- Mesh fabric allows bag to double up as an air dry bag
- Elasticated belt loop for holding catapult/throwing stick
- Adjustable waist strap can also be used to hang on branches etc
- 100% treated 500 denier polyester

*RRP

CLU318 Camo Boilie Bum Bag L £16.99

CLU317 Camo Boilie Bum Bag S £14.99

Contents not included



NEW

CAMOLITE™ CHAIR BAG

- Unique Fox Camo pattern
- Stiffened EVA handles
- Double Heavy Duty zips
- Padded removable shoulder strap
- Ideal for storing all Fox chairs
- 100% treated 500 denier polyester

*RRP

CLU313 Camo Chair Bag £36.99



NEW

CAMOLITE™ LARGE SPOOL CASE

- Unique Fox Camo pattern
- Stiffened along entire length for full crush protection
- Double zip with webbing bridge for ease of opening
- Wipe clean liner to keep grit and debris out of your spools
- Supplied with three foam dividers
- Holds four big pit spools
- 100% treated 500 denier polyester

*RRP

CLU308 Camo Large Spool Case £15.99



NEW

CAMOLITE™ 5LTR, 10LTR & 17LTR SQUARE BUCKETS

- Available in 5L, 10L and 17L
- Perfect for spod mixes, maggots and groundbaits
- Square design makes them much more barrow-friendly than a more conventional round bucket
- Easier to stack and also easier to store in your car
- Extra strong metal handle



		*RRP
CBT005	Camo Square Bucket 5L	£5.99
CBT006	Camo Square Bucket 10L	£7.99
CBT007	Camo Square Bucket 17L	£9.99



Perfect for a variety of baits



Extra strong metal handle



CAMOLITE™ 17LTR & 10LTR BUCKET CARRYALLS

- Designed to work with 10L or 17L Fox Camo Bucket (available to purchase separately, see below)
- Bucket simply slides into central section to create a unique carryall
- Perfect for the mobile angler that likes to go stalking, surface fishing etc
- Two external side pockets for storing essential accessories – one of which is insulated making it ideal for keeping food or bait fresh
- Front pocket fits a large Fox tackle box
- Elasticated loop for storage of catapult or throwing stick
- Padded, wipe clean flap that creates a seat
- Padded, removable shoulder strap

- High quality Heavy Duty double zips
- 100% treated 5000 denier polyester material
- Styled in unique Fox Camo pattern
- Main outer fabric: 100% Polyester
Lining: 100% Polyester
Padding/Filling: 100% Polyurethane
Base: 100% (PVC) Polyvinyl chloride

		*RRP
CLU305	Camolite 10L Bucket Carryall	£39.99
CLU306	Camolite 17L Bucket Carryall	£44.99

17ltr Buckets not included



10ltr



FOX CAMOLITE



57cm



31cm

CAMOLITE™ BARROW BAG

- Perfect for use with Explorer Barrow with retaining panel on rear designed for fixing bag to Explorer Barrow
- Perfect for storing tackle, bait and clothing
- Stiffened EVA grab handles
- Removable, padded 3D shoulder strap
- External and internal mesh pockets
- Two external zipped pockets for extra storage
- Gusseted front hatch for easy access to tackle box and essentials
- Reinforced base and lid
- 10mm Heavy Duty double zips
- 100% treated 500 denier polyester material
- Styled in unique Fox Camo pattern
- Main outer fabric: 100% Polyester
Lining: 100% Polyester
Padding/Filling: 100% Polyethylene
Base: 100% Ethylene Vinyl Acetate Copo (EVA)



CLU285 Camolite Barrow Bag *RRP
£99.99

CAMOLITE™ LOW LEVEL CARRYALL

- Low profile carryall that can be stored under your bedchair
- Designed to work in conjunction with Explorer Barrow – retaining panel on rear allows carryall to be fixed to front bar of Explorer Barrow
- Two external side storage pockets – ideal for accessories such as PVA etc
- Zipped mesh storage pockets on outside side pockets
- Top pocket designed for storage of large Fox tackle box
- Main compartment perfect for storing host of tackle items including smaller Camolite Accessory Bags
- Reinforced moulded base
- Stiffened EVA grab handles
- Padded, removable shoulder strap
- High quality Heavy Duty double zips
- 100% treated 5000 denier polyester material
- Styled in unique Fox Camo pattern

- Main outer fabric: 100% Polyester
Lining: 100% Polyester
Padding/Filling: 100% Polyethylene
Base: 100% Ethylene Vinyl Acetate Copo (EVA)



54cm



29cm



CLU298 Camolite Low Level Carryall *RRP
£99.99

CAMOLITE™ RUCKALL

- Unique design that combines the benefits of a rucksack and carryall in one
- Padded, 3D non-slip shoulder straps and a padded back section make Ruckall very comfortable to carry
- Padded back becomes lid when Ruckall is placed on the ground
- Reinforced moulded base
- One side features a full length external storage pocket whilst the other features two smaller external storage pocket – all of which are perfect for storing a variety of accessories
- Two removable straps allow a chair and/or unhooking mat to be attached to the Ruckall for hands-free carrying
- Elasticated pocket inside lid for storage of tackle box
- Low profile allows for easy storage under your bedchair
- High quality Heavy Duty double zips
- 100% treated 5000 denier polyester material
- Styled in unique Fox Camo pattern
- Main outer fabric: 100% Polyester
Lining: 100% Polyester
Base: 100% Ethylene Vinyl Acetate Copo (EVA)



CLU307 Camolite Ruckall *RRP
£99.99



50cm

43cm

27cm

CAMOLITE™ COOLBAG

- Features top quality thermal lining
- Available in two sizes – Standard and Large
- Ideal for storing items such as bait and food
- Designed to fit perfectly inside the central Under Barrow Bag on the Explorer barrow
- Side handles make them easy to remove from central Under Barrow Bag on Explorer barrow
- 8mm Heavy Duty double zips
- 100% treated 500 denier polyester material
- Styled in unique Fox Camo pattern
- Main outer fabric: 100% Polyester
Lining: 100% Polyethylene Terephthalate
Padding/Filling: 100% Polyethylene
- Dimensions:
Standard – L 39cm x W 18cm x H 15cm
Large – L 40cm x W 30cm x H 20cm



*RRP

CLU282	Camolite Coolbag Large	£26.99
CLU283	Camolite Coolbag Standard	£21.99

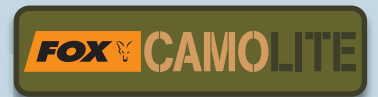

Cool Bag features a quality thermal lining



Can be added and removed through side pocket of under barrow bag on Explorer Barrow



Ideal for storing gas canisters and cookware (contents not included)

CAMOLITE™ STANDARD STORAGE BAG

- Ideal for storing items such as stove, gas canisters and cookware
- Designed to fit perfect inside the central Under Barrow Bag on the Explorer barrow
- Side handles make them easy to remove from central Under Barrow Bag on Explorer barrow
- 8mm Heavy Duty double zips
- 100% treated 500 denier polyester material
- Styled in unique Fox Camo pattern
- Main outer fabric: 100% Polyester
Lining: 100% Polyester
Padding/Filling: 100% Polyethylene
- Dimensions: W 39cm x H 15cm x D 18cm



*RRP

CLU284	Camolite Standard Storage Bag	£17.99
--------	-------------------------------	--------

CAMOLITE™ LOW LEVEL COOL BAG

- Low profile carryall that can be stored under your bedchair
- Designed to work in conjunction with Explorer Barrow – retaining panel on rear allows carryall to be fixed to front bar of Explorer Barrow
- Main compartment is insulated with an removable/adjustable divider – perfect for storing bait and/or food and keeping it fresh
- Top pocket also insulated with a removable/adjustable divider – again perfect for food and/or bait and keeping it fresh
- Reinforced moulded base
- Stiffened EVA grab handles
- Padded, removable shoulder strap
- High quality Heavy Duty double zips
- 100% treated 5000 denier polyester material
- Styled in unique Fox Camo pattern
- Main outer fabric: 100% Polyester
Lining: 100% Polyethylene Terephthalate
Padding/Filling: 100% Polyethylene
Base: 100% Ethylene Vinyl Acetate Copo (EVA)



*RRP

CLU299	Camolite Low Level Cool Bag	£84.99
--------	-----------------------------	--------





Large perfect for items like PVA and Impact Spods



Slim ideal for items like Zig and Marker Floats



Medium suited to a variety of products



Small is ideal for storing your chosen leads



CAMOLITE™ ACCESSORY BAG LARGE

- Perfect for storing accessories such as PVA, Edges end tackle, Zig and floater fishing items etc
- Clear lid allows for easy identification of contents
- Low profile grab handle
- High quality Heavy Duty double zips
- 100% treated 5000 denier polyester material
- Styled in unique Fox Camo pattern
- Main outer fabric: 70% Polyester, 30% PVC. Lining: 100% Polyester
- Dimensions: W 16cm x H 9.5cm x L 27cm



*RRP

CLU303 Camolite Accessory Bag Large £13.99

CAMOLITE™ ACCESSORY BAG SLIM

- Perfect for storing accessories such as Zig floats, Impact Spods and Edges end tackle
- Clear lid allows for easy identification of contents
- Low profile grab handle
- High quality Heavy Duty double zips
- 100% treated 5000 denier polyester material
- Styled in unique Fox Camo pattern
- Main outer fabric: 70% Polyester, 30% PVC. Lining: 100% Polyester
- Dimensions: W 9.5cm x H 9.5cm x L 27cm



*RRP

CLU304 Camolite Accessory Bag Slim £13.99

CAMOLITE™ ACCESSORY BAG MEDIUM

- Perfect for storing accessories such as line, Edges end tackle, tools etc
- Clear lid allows for easy identification of contents
- Low profile grab handle
- High quality Heavy Duty double zips
- 100% treated 5000 denier polyester material
- Styled in unique Fox Camo pattern
- Main outer fabric: 70% Polyester, 30% PVC. Lining: 100% Polyester
- Dimensions: W 13cm x H 9.5cm x L 16.5cm



*RRP

CLU302 Camolite Accessory Bag Medium £11.99

CAMOLITE™ ACCESSORY BAG SMALL

- Perfect for storing accessories such as rig tools, Edges end tackle and leads
- Clear lid allows for easy identification of contents
- Low profile grab handle
- High quality heavy double zips
- 100% treated 5000 denier polyester material
- Styled in unique Fox Camo pattern
- Main outer fabric: 70% Polyester, 30% PVC. Lining: 100% Polyester
- Dimensions: W 8.5cm x H 9.5cm x L 13cm



*RRP

CLU301 Camolite Accessory Bag Small £8.99

CAMOLITE™ PILLOWS

NEW

- Dual sided
- Micro fleece on one side to keep you warm in winter
- Soft cotton on the other side to keep you cool in summer
- Removable cover can be cleaned
- Two sizes available: Standard and XL

*RRP

CLU314 Camolite Standard Pillow £17.99

CLU315 Camolite XL Pillow £22.99



NEW

**CAMOLITE™
GLUG 8 POT CASE**

- Unique Fox Camo pattern
- Double Heavy Duty zips
- 4 full size hookbait pots
- 4 half size hookbait pots
- Padded dividers
- Tinted PVC lid for easy contents identification
- 100% treated 500 denier polyester

CLU310 Camolite Glug 8 Pot Case *RRP £25.99



Padded dividers



Tinted hookbait pots in 2 sizes



Tinted PVC lid for easy contents identification



NEW

**CAMOLITE™
GLUG 6 POT CASE**

- Unique Fox Camo pattern
- Double Heavy Duty zips
- 2 full size hookbait pots
- 4 half size hookbait pots
- Padded dividers
- Tinted PVC lid for easy contents identification
- 100% treated 500 denier polyester

CLU311 Camolite Glug 6 Pot Case *RRP £20.99

NEW

**CAMOLITE™
LEAD AND BITS BAG**

- Unique Fox Camo pattern
- Double Heavy Duty zips
- Solid insert to prevent buckling
- Stiffened EVA handle
- Tinted PVC lid for easy contents identification
- 100% treated 500 denier polyester



CLU312 Camolite Lead & Bits Bag *RRP £25.99



Tear and water resistant 1200 denier treated polyester is used throughout the range to ensure durability



Specially strengthened and chunky double 10mm zips are standard throughout the range



ROYALE® 3 ROD HOLDALL

- Fully padded with large, central padded divider to fully protect your rods
- Holds three made-up rods and three unmade rods
- Padded reel section easily accommodates big pit models
- Aluminium spine stiffener
- Velcro rod fasteners are perfectly sized with ergonomically designed rubber tab ends for ease of use
- Two external pockets; one for banksticks, one for storm pole and landing net etc
- Available in 12ft and 13ft
- Main outer fabric 100% Polyester, Padding/Filling 70% Polyethylene 30% Polyurethane, Lining 100% Polyester
- Dimensions:
12ft: 196cm x 31cm
13ft: 209cm x 31cm

ROYALE® 4 ROD HOLDALL

- Features the same specifications as the 3-rod version, but is designed to house four made up and four unmade 13ft rods
- Fully padded with large, central padded divider to fully protect your rods
- Padded reel section easily accommodates big pit models
- Aluminium spine stiffener
- Velcro rod fasteners are perfectly sized with ergonomically designed rubber tab ends for ease of use
- Two external pockets; one for banksticks, one for storm pole and landing net etc
- Main outer fabric 100% Polyester, Padding/Filling 20% Polyethylene 80% Polyurethane, Lining 100% Polyester
- Dimensions: 13ft: 209cm x 39cm

		*RRP
CLU170	Royale 3-Rod 12ft Holdall	£99.99
CLU171	Royale 3-Rod 13ft Holdall	£109.99

		*RRP
CLU172	Royale 4-Rod 13ft Holdall	£119.99



Fixed and moulded EVA padding prevents straps from sliding whilst in use



All buckles and clips are made from shatter-proof nylon ensuring they stand the test of time



ROYALE® 4 ROD QUIVER COMBO

- Supplied with three padded, protective jackets
- Internal compartment will hold a 60ins brolly, brolly system or Reflex Compact
- Double zipped for ease of access
- Removable strap for use on barrows
- Three external pockets to house net pole, banksticks, landing net and storm poles
- Three compression straps hold rod sleeves securely
- All sleeves individually clip secured
- 12 and 13ft versions available
- Main outer fabric 100% Polyester, Padding/Filling 5% Polyethylene 95% Polyurethane, Lining 100% Polyester
- Dimensions:
12ft: 198cm x 24cm
13ft: 210cm x 24cm

ROYALE® SINGLE JACKETS 10, 12 & 13FT

- Specially sculpted profile to accept 50mm butt rings
- Two stiffened EVA grab handles
- Reel forward design with double zips up the rod spine to protect your line
- Top 15 cm of the jacket is not zipped so your rod is held in situ when you zip up the jacket – no more fiddling!
- Reel section gusseted to accommodate all big pit models
- Hanging loop at top
- Main outer fabric 100% Polyester, Padding/Filling 100% Polyurethane, Lining 100% Polyester
- Dimensions:
10ft: 165cm x 24cm
12ft: 198cm x 24cm
13ft: 210cm x 24cm

		*RRP
CLU193	Royale 4-Rod Quiver Combo inc 3x 12ft Jacket	£149.99
CLU173	Royale 4-Rod Quiver Combo inc 3 x 13ft Jacket	£159.99

		*RRP
CLU244	Royale Single 10ft Rod Sleeve	£24.99
CLU194	Royale Single 12ft Jacket	£28.99
CLU174	Royale Single 13ft Jacket	£27.99



Tear and water resistant 1200 denier treated polyester is used throughout the range to ensure durability



Specially strengthened and chunky double 10mm zips are standard throughout the range



ROYALE® TRI-SLEEVE 12 & 13FT

- Will house three made up rods
- Sculpted to fit 50mm butt rings and bit pit reels
- Ideal for anglers who only wish to carry three rods to and from a swim
- Stiffened EVA grab handles
- External pocket for landing net storage
- Reversible, padded shoulder strap
- New 13ft model also available
- Main outer fabric: 100% Polyester
- Dimensions:
12ft: 192cm x 36cm x 30cm
13ft: 203cm x 37cm x 30cm

ROYALE® TRI-SLEEVE 12FT 3-PIECE

- Will house three made up 3-piece rods
- Sculpted to fit 50mm butt rings and bit pit reels
- Ideal for anglers who only wish to carry three rods to and from a swim
- Perfect for anglers with small cars
- Stiffened EVA grab handles
- External pocket for landing net storage
- Reversible, padded shoulder strap
- Also good for housing the new EOS Telescopic rods
- Main outer fabric: 100% Polyester
- Dimensions: 135cm x 30cm x 30cm

		*RRP
CLU281	Royale 12ft Tri-Sleeve	£64.99
CLU294	Royale 13ft Tri-Sleeve	£74.99

		*RRP
CLU296	Royale Tri-Sleeve 12ft 3pc	£69.99

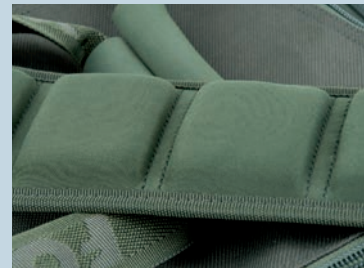

Fixed and moulded EVA padding prevents straps from sliding whilst in use



All buckles and clips are made from shatter-proof nylon ensuring they stand the test of time

ROYALE® 2 ROD SLEEVES

- Will house two made up rods
- Sculpted to fit 50mm butt rings and bit pit reels
- Ideal for anglers who only use two rods
- Also ideal for storing spod and marker rod
- External pocket for landing net storage
- Reversible, padded shoulder strap
- 10ft and 12ft models available
- Main outer fabric: 100% Polyester
- Dimensions:
10ft: 162cm x 26cm x 26cm
12ft: 192cm x 34cm x 26cm

		*RRP
CLU268	Royale 12ft 2-Rod Sleeve	£59.99
CLU269	Royale 10ft 2-Rod Sleeve	£54.99

ROYALE® BROLLY CARRYALL SYSTEM

- Ideal for use with Royale and Ultra 60 broolly ranges
- Will accommodate either loose rods, Single Rod Jackets, Royale 2-Rod Sleeve, Royale Tri-Sleeve, Voyager Tri Sleeve or Single Rod Jackets on the outside pocket
- 1200 Denier Treated Polyester
- 10mm Heavy Duty Double Zips
- Zip configuration allows for easy loading.
- Removable Padded Shoulder Strap
- Stiffened EVA Grab Handle
- Compression Straps
- Main outer fabric: 100% Polyester
- Dimensions: 172cm x 32cm x 28cm

		*RRP
CLU264	Royale Brolly Carryall System	£36.99



Tear and water resistant 1200 denier treated polyester is used throughout the range to ensure durability



Specially strengthened and chunky double 10mm zips are standard throughout the range



All buckles and clips are made from shatter-proof nylon ensuring they stand the test of time



Contents not included

ROYALE® BEDCHAIR BAG

- Available in Large (for R1, R2, Warrior 2 beds plus Flatliner and Flatlitter MK2) and XL (for R3 and Warrior 2 XL)
- Fits most bedchairs on the market
- Sized to allow space for a light sleeping bag and pillow
- Main outer fabric: 100% Polyester
Padding/Filling: 100% Polyethylene
Lining: 100% Polyester

		*RRP
CLU237	Royale XL Bedchair Bag	£54.99
CLU238	Royale Large Bedchair Bag	£49.99



ROYALE® SLEEPING BAG CARRYALL

- Available in two sizes – Standard and XL (for Kingsize Sleeping Bags)
- Perfect for transporting your sleeping bag to and from a venue
- Reinforced, waterproof base
- 10mm heavy-duty zips
- Stiffened EVA handles
- Reinforced tension straps for tight compression
- Main outer fabric: 100% Polyester
Base: 100% Polyvinyl Chloride (PVC)

		*RRP
CLU259	Royale Sleeping Bag Wrap Standard	£27.99
CLU260	Royale Sleeping Bag Wrap XL	£32.99



Contents not included

ROYALE® LEAD & BITS BAG

- Versatile storage for leads, Method feeders and similar items
- Stiffened EVA grab handle on top
- Zipped mesh accessory pocket
- Two stiffened inserts with Velcro fastening for you to customise to your own requirements
- Main outer fabric: 100% Polyester
Padding/Filling: 100% Polyethylene
Lining: 100% Polyester
- Dimensions: 22cm x 8cm x 14cm

CLU178	Royale Lead and Bits Bag	*RRP £16.99
--------	--------------------------	----------------



ROYALE® ALARM POUCH

- High Denier Polyester
- Padded Protection
- Securing Draw Cord
- Main outer fabric: 100% Polyester
Padding/Filling: 100% Polyurethane
Lining: 100% Polyester

CLU255	Royale Alarm Pouch	*RRP £6.49
--------	--------------------	---------------



Contents not included

ROYALE® BUZZ BAR BAG

- Well padded bags to give ultimate protection to alarms and buzz bars
- Zipped mesh pocket to house hangers and small indicators
- Velcro loops secure all buzz bars and prevent movement during transport
- Dimensions:
2-3 rods - 51cm x 6cm x 23cm

CLU182	Royale 2-3 Rod Buzz Bar Bag	*RRP £20.99
--------	-----------------------------	----------------



ROYALE® DIP BAG

- Designed for storage of special hookbaits, dips and liquids
- Stiffened EVA grab handle on top
- Zipped mesh pocket in lid for baiting needles, tools and stops etc
- Supplied with six Fox-moulded watertight screw top tubs
- Main outer fabric: 100% Polyester
Lining: 100% Polyvinyl Chloride (PVC)
- Dimensions: 25cm x 12cm x 16cm

CLU177	Royale Dip Bag	*RRP £24.99
--------	----------------	----------------



MEDIUM



LARGE



X.LARGE



ROYALE® CARRYALL MEDIUM

- 56l capacity
- Three external pockets:
 - Front pocket holds a large single F Box
 - Two side pockets house either one large or two medium accessory bags
- Main outer fabric: 100% Polyester, Padding/Filling: 100% Polyethylene, Lining 100% Polyester

		*RRP
CLU169	Royale Carryall M	£54.99



ROYALE® CARRYALL LARGE

- 80l capacity
- Three external pockets:
 - Front pocket houses a large double F Box and a medium accessory bag
 - Two side pockets each hold one large and one medium accessory bag
- Main outer fabric: 100% Polyester, Padding/Filling: 100% Polyethylene, Lining 100% Polyester

		*RRP
CLU168	Royale Carryall L	£59.99



ROYALE® CARRYALL X-LARGE

- Massive 128l capacity
- Six external pockets:
 - Front pocket holds a large, double F Box and two accessory bags
 - Two rear pockets each hold a large, double F Box
 - Large side pocket holds a large, single F Box
 - Small side pockets are stepped to allow easy access; the smaller houses two small accessory bags, the larger a medium accessory bag
- Main outer fabric: 100% Polyester, Padding/Filling: 100% Polyethylene, Lining: 100% Polyester

		*RRP
CLU167	Royale Carryall XL	£64.99



Compact

Standard

		*RRP
CLU270	Royale Barrow Bag Compact	£74.99
CLU271	Royale Barrow Bag Standard	£84.99
CLU295	Royale Barrow Bag XL	£104.99

ROYALE® BARROW BAGS

- Available in Compact, Standard and new XL sizes
- Manufactured from 100% treated 1200 denier polyester nylon
- Moulded base and lid
- Perfect for secure loading onto barrow
- 10mm heavy duty zips and shatter-proof nylon buckles
- 2 x external side pockets for storing tackle essentials
- Compact and Standard feature 1 x external central pocket for tackle box storage
- XL features 2 x external front pockets for tackle box and additional storage
- Stiffened EVA grab handles
- Removable, padded shoulder strap
- Main outer fabric 100% Polyester
- Dimensions:
 - Compact - L 50cm x W 35cm x H 44cm
 - Standard - L 60cm x W 38cm x H 42cm
 - X-Large - L 82cm x W 36cm x H 44cm



ROYALE® 40L RUCKSACK

- Perfect for the mobile or roving angler
- Fully adjustable straps and '3D' mesh on the shoulder straps and back panel for breathability
- 40L main body compartment
- Four external pockets:
 - Front pocket holds a large double F Box
 - Lid pocket holds medium double F Box
 - Two side pockets hold either one large or three small accessory bags
- Fully adjustable shoulder harness and waist strap
- Zipped mesh pocket in lid
- Main outer fabric: 100% Polyester, Padding/Filling: 85% Polyethylene, 15% Polyurethane Lining: 100% Polyester



The lid pocket of the Royale 40L Rucksack has been designed to comfortably fit a Medium Double F-Box tackle box

CLU195 **Royale Rucksack - 40ltr** *RRP
£59.99

ROYALE® COOLER BAG

- Thermally insulated wipe clean lining
- Perfect for session storage of bait, food or drinks
- Stiffened EVA handles
- Double 10mm zips
- Main outer fabric: 100% Polyester
Padding/Filling: 100% Polyethylene
Lining: 100% Polyethylene Terephthalate
- Dimensions: 39cm x 25cm x 28cm



Contents not included

CLU190 **Royale Cooler Bag** *RRP
£34.99

ROYALE® BOILIE/STALKING POUCHES

- Perfect for keeping bait to hand when using a catapult or throwing stick
- Great for the roving angler who likes to travel light
- Made from same top quality materials as everything in the Royale range
- Handy pockets on front for storing essential items
- Adjustable waist strap
- Available in Standard and XL
- Main outer fabric: 100% Polyester
- Dimensions:
 - Std - 29cm x 20cm x 14cm
 - XL - 35cm x 26cm x 20cm



*RRP

CLU242	Royale Boilie Pouch Std	£13.99
CLU243	Royale Boilie Pouch XL	£15.99

ROYALE® BARROW FRONT BAG

- Designed to fit on front bar of Royale and Royale XT barrows
- Double 10mm heavy-duty zips
- Velcro dividers for organised storage
- Perfect place to store water bottle and other heavy items to distribute weight over front wheel of barrow
- Stiffened base
- Carry handle on top
- Main outer fabric: 100% Polyester, Padding/Filling: 100% Polyethylene, Lining: 100% Polyester



CLU265 **Royale Barrow Front Bag** *RRP
£36.99



FREE
Hookbait Air Dry Bag



ROYALE® AIR DRY BAGS

- Available in Medium and Large
- Both bags come supplied with FREE Hookbait Air Dry Bag
- Reinforced carry/hanging handles
- Drawcord top
- Main outer fabric 100% Polyester

		*RRP
CLU272	Large Air Dry Bag	£14.99
CLU273	Medium Air Dry Bag	£12.99



The Royale Bait Bag is thermally lined to ensure that your bait of choice is kept fresher for longer. This lining can also be wiped clean very easily to ensure your bag and bait stay in tip top condition!



ROYALE® COMPACT BUCKETS

- Perfect for the mobile angler that requires a compact piece of luggage for storage of boilies, pellets, groundbaits and other baits
- Available in two sizes – Medium and Large
- Collapsible when empty to maximise storage and transport space
- Wipe clean internal lining
- Double zipped and buckle-fastened lid (large only) to keep contents secure, fresh and to prevent spillage

- Main outer fabric: 100% Polyester
Lining: 100% Polyvinyl Chloride (PVC)
- Dimensions:
Large - H 30cm x Ø32cm
Medium - H 16cm x Ø28cm

		*RRP
CLU191	Royale Compact Bucket Large	£18.99
CLU192	Royale Compact Bucket Medium	£15.99



ROYALE® BAIT BAG

- Perfect for keeping frozen boilies or deadbaits in top condition
- Can also be used for chilled food and drink storage
- One removable, internal thermally lined compartment
- Fully thermally lined, wipe clean lining
- Three external pockets:
 - Front pocket accommodates a large single F Box
 - Two side pockets each hold a large accessory bag or Rig Wallet

- Zipped pocket in lid
- Main outer fabric: 100% Polyester
Padding/Filling: 100% Polyethylene
Lining: 100% Polyethylene
- Dimensions: 54cm x 31cm x 38cm

		*RRP
CLU189	Royale Bait Bag	£59.99



ROYALE® COOLER FOOD BAG SYSTEM

- Central, thermally insulated and easy clean main compartment with a 60:40 divider for compartmentalised food storage
- Two large padded and double zipped external pockets for your stove, canned food and accessories
- Large front pocket opens into a fold out utensil store containing: 2 x stainless steel knives, forks, spoons and teaspoons, 2 x square black Melamine plates with Fox logo, 2 x green mugs, 1 x corkscrew, 1 x plastic chopping board, 2 x large screw top tubs, 2 x small screw top tubs, 1 x Micro fleece towel
- Internal recessed storage area for oil, ketchup and sauces, washing up liquid etc
- Full length double 10mm zips
- Exterior features include: two detachable, thermally lined bottle storage units with draw cord tops for wine/ water/ fuel canisters
- Adjustable and removable shoulder strap
- Main outer fabric: 100% Polyester
Padding/Filling: 100% Polyethylene
Lining: 100% Polyester
- Dimensions: 67cm x 34cm x 30cm

		*RRP
CLU235	Royale Cooler Food Bag System	£89.99



Contents not included

ROYALE® COOKSET BAGS

- Result of popular demand
- Available in two sizes
- Large accommodates Fox 4-Piece Cookware Set
- Standard accommodates Fox 3-Piece Cookware Set
- Reinforced base
- Stiffened EVA carry handle
- Double 10mm heavy duty zips
- Main outer fabric 100% Polyester

		*RRP
CLU276	Cookset Bag (3pc)	£9.99
CLU277	Cookset Bag (4pc)	£11.99



ROYALE® 1 & 2 MAN DINNER SETS

- Stiffened EVA handles
- Handy for short sessions
- Main outer fabric: 100% Polyester
Padding/Filling: 100% Polyethylene
Lining: 100% Polyester
- 1 Man comes supplied with: 1 x stainless steel knife, fork, spoon and teaspoon, 1 x square black Melamine plate with Fox logo, 1 x green mug, 1 x corkscrew, 1 x plastic chopping board, 1 x large screw top tub, 1 x small screw top tub, 1 x Micro fleece towel
- 2 Man comes supplied with: 2 x stainless steel knives, forks, spoons and teaspoons, 2 x square black Melamine plates with Fox logo, 2 x green mugs, 1 x Corkscrew, 1 x plastic chopping board, 2 x large screw top tub, 2 x small screw top tubs, 1 x Micro fleece towel

		*RRP
CLU240	Royale 1-Man Dinner Set	£37.99
CLU241	Royale 2-Man Dinner Set	£49.99



ROYALE® MUG

- Carpy green plastic mugs that are perfect for hot drinks
- Features gold Fox head

		*RRP
CLU252	Royale Mug	£3.25



BAIT & GLUG TUBS

- Perfect for storing a range of hookbaits
- Screw top enables liquids to be stored without leaking
- Clear body for easy identification of hookbaits
- Available in both full and half-size options
- Six tubs per packet

		*RRP
CAC393	Bait Tubs Full Size x6	£13.99
CAC394	Bait Tubs Half Size x6	£12.99



ROYALE® ACCESSORY BAGS

- Designed to fit into the exterior pockets of the Royale Rucksack, Carryalls and Bait Bag
- Available in three sizes – Large, Medium and Small
- Zipped mesh pocket in lid
- Stiffened EVA grab handle (large model only)
- Main outer fabric 100% Polyester
- Dimensions:
Large - 26.5cm x 8cm x 17cm
Medium - 22cm x 8cm x 13cm
Small - 16cm x 8cm x 10cm

		*RRP
CLU179	Royale Accessory Bag - L	£13.99
CLU180	Royale Accessory Bag - M	£12.99
CLU181	Royale Accessory Bag - S	£11.99



Contents not included

ROYALE® REEL CASE

- Double zipped and stiffened to give ultimate protection for your reels
- XL version accommodates big pit models
- Large version houses all other models
- Main outer fabric: 100% Polyester
Padding/Filling: 100% Polyethylene
Lining: 100% Polyester
- Dimensions:
Large - 22cm x 10.5cm x 16cm
X.Large - 24cm x 10.5cm x 18cm

		*RRP
CLU175	Royale Reel Case - L	£10.99
CLU176	Royale Reel Case - XL	£11.99

ROYALE® SPOOL TUBE

- Designed to keep your all-important spare spools in pristine condition when not in use
- Supplied with two foam dividers
- Large tube will house three big pit spools; medium tube three 10,000 sized spools
- Double zip with webbing bridge for ease of access
- Stiffened for extra protection
- Main outer fabric: 100% Polyester
Padding/Filling: 30% Polyethylene 70% Polyurethane
Lining: 100% Polyvinyl Chloride (PVC)



Contents not included

		*RRP
CLU186	Spool Tube Medium	£11.99
CLU187	Spool Tube Large	£12.99



NEW

AQUOS® EVA BAGS

- Waterproof EVA construction with welded seams to prevent water ingress
- Oversized lid
- Heavy duty double zips
- Polyester webbing handles with EVA comfort grip
- Scuff pads on base
- Ideal for boat users who want to keep tackle items dry
- Can also be used for holding bait/spod mixes or wet items such as sacks, clothes, waders (30l only) etc
- Dimensions:
20l - 37cm x 26cm x 27cm
30l - 40cm x 26cm x 30cm

		*RRP
CLU321	Aquos EVA Bag 20L	£20.99
CLU322	Aquos EVA Bag 30L	£24.99



Waterproof EVA construction with welded seams to prevent water ingress



Polyester webbing handles with EVA comfort grip



Scuff pads on base



FX GAS CANISTER COVER

- Hardwearing Neoprene main body
- Zipped base for easy insertion of gas bottle
- Hardwearing base for added protection
- Two elasticated retaining loops: one for lighter and one for spoon
- Will fit 500g canisters
- Main outer fabric: 100% Neoprene

		*RRP
CLU280	FX Gas Canister Cover	£10.99



Retaining loops for lighter and spoon

STAINLESS STEEL MUG

- Features our catchy slogan: Find 'em, Feed 'em, Fox 'em
- Designed to keep your hot drinks warmer for longer
- Easy to clean

		*RRP
CLU254	Stainless Black XL 400ml Mug FFF	£10.99





Camo barrow cover supplied with Deluxe Explorer



Mesh pockets feature side access and are ideal for water bottles



Deluxe under barrow bag features shelf



Extending front bar allows two bags to be attached



Both Explorer models come supplied with barrow straps



NEW

EXPLORER® BARROW DELUXE

- Based on same unique design as original Explorer barrow but with some added extras!
- Designed to allow anglers to fish 'off of the barrow' making it ideal for short-session anglers that like to keep mobile but also equally as good for anglers that need to carry those essential extras
- Main differences to standard Explorer: longer ergonomically shaped, removable handles, wider compartments and mesh pockets either side of wheel for storing essentials such as water bottle, adjustable height on front barrow rack allowing 2 x Low Level bags or 1 x Low Level and 1 x Compact Barrow Bag to be attached and supplied with a Voyager Under Barrow Bag
- Voyager Under Barrow Bag features hard base to prevent sagging, a removable shelf to allow Storage Bags to be separated and side access zips to allow the contents of the bag to be accessed without unloading the barrow
- Another feature of the Voyager Under Barrow Bag is a zipped external pocket that houses a waterproof rain cover, which is styled in the Fox Camo pattern
- Features extendable front barrow bag rack – this allows the Voyager or Camolite Compact Barrow Bags or Low Level Bags (all available separately) to sit right at the front of the barrow when using the barrow in 'session mode' and carrying a bedchair. However, when fishing day sessions without a bed, simply retract the front rack and turn the Barrow/Low Level Bags around so they face you. The design ensure the barrow remains balanced whether in short or long session mode
- Further features include robust, hi-tensile steel frame, quick release wheel system with pneumatic tyre and swivelling mud feet with spiked bases
- Compact design and packs down very small for fitting in smallest of car boots
- Supplied with two Universal Barrow Straps that fit to barrow via looped attachments on frame
- Compatible with both the Voyager and Camolite luggage ranges

*RRP

CTR013 Explorer Deluxe Barrow £199.99



EXPLORER® BARROW

- Unique design makes it one of the most versatile carp barrows ever released
- Designed to allow anglers to fish 'off of the barrow' making it ideal for short-session anglers that like to move swims a lot
- Extendable front barrow bag rack – this allows the Camolite Barrow Bag (available separately) to sit right at the front of the barrow when using the barrow in 'session mode' and carrying a bedchair. When fishing days without a bed, simply retract the front rack and turn the Barrow Bag round so it faces you. The design ensure the barrow remains balanced whether in short or long session mode
- Ergonomically shaped removable handles
- Robust, hi-tensile steel frame that is built to last
- Quick release wheel system with pneumatic tyre
- Swivelling mud feet with spiked bases
- Compact design and packs down very small for fitting in smallest of car boots
- Supplied with two FX Universal Barrow Straps that fit to barrow via looped attachments on frame
- Supplied with camo storage bag that simply 'drops in' to the centre of the frame, which can then be loaded with tackle items including Camolite Storage Bags that are available separately
- Camo storage bag has side access points so contents can be taken out without unloading barrow
- Supplied with two mesh storage pockets (with side access) that sit either side of wheel for storing water bottle etc
- Compatible with our Camolite luggage range

*RRP

CTR012 Explorer Barrow £189.99



Compact when packed away

ROYALE® CARP BARROW

- Packed with features that make it offer incredible value for money
- Extra wide design to fit all of your kit
- Quick and simple load length adjustment
- Quick release wheel system
- Compression strap attachment points on frame for use with FX Universal Barrow Straps
- Ergonomically shaped handles
- Low profile
- Swivelling mud feet with spiked bases for extra stability
- Pneumatic tyre and wheel bearings
- Supplied with free under barrow bag
- Ideal for use with Royale Barrow Bags (see page 99)



Supplied with pneumatic tyre

		*RRP
CTR009	Royale Carp Barrow with Bag	£119.99



Welded loops for attaching FX Universal Barrow Straps



Ergonomically designed handles

ROYALE® XT CARP BARROW (NOT AVAILABLE IN UK)

- Based on same design as standard Royale but with addition of extending sides
- Extra wide design to fit all of your kit
- Quick and simple load length adjustment
- Adjustable side support
- Quick release wheel system
- Compression strap attachment points on frame for use with FX Universal Barrow Straps
- Ergonomically shaped handles
- Low profile
- Swivelling mud feet with spiked bases for extra stability
- Pneumatic tyre and wheel bearings
- Supplied with free under barrow bag
- Ideal for use with Royale Barrow Bags (see page 99)

		*RRP
CTR010	Royale Carp Barrow XT with Bag	N/A





BOATS & ENGINES

It has been only three years since we entered the inflatable boat market, but the growth in popularity of our offerings in that time has been staggering. It doesn't seem that a week goes by without us receiving positive feedback via social media, email or at shows from very happy anglers based all across the globe! For this 2018 catalogue we are sticking with the tried, tested and trusted sizes from 2017, which are the FX200, FX240, FX290 and FX320. However, such was the popularity of our Fox Camo additions to the FX200 and FX240 in the 2017 catalogue, we are pleased to say we now offer our larger FX290 and FX320 in a Fox Camo option too!

All our FX boats have been manufactured to the highest standards and are designed to stand up to the requirements of the modern boat angler. The four sizes currently available in the range cover many bases meaning that whether you are looking for something for baiting up, placing rigs, landing weeded fish or indeed fishing from, then you are sure to find it within the FX range.

In addition to the range of inflatable boats we also produce three models of FX Pro electric engines, as well some handy accessories such as a rechargeable pump and some Black Label Line Guards that enable you to place rigs with your boat in locations that you wouldn't normally be able to cast to!



Reinforced mounting points for engines etc.

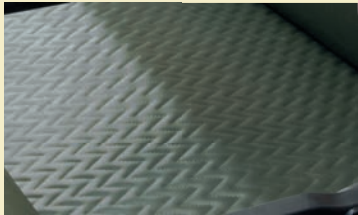

Air mattress floor option available

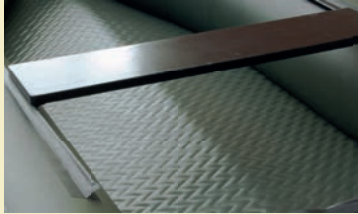

Fully adjustable rail seat

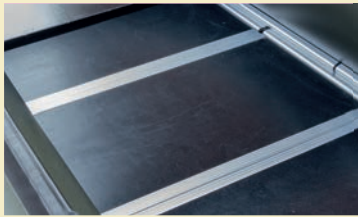

Marine plywood floor option available



FX 320

- The largest of the FX range measuring 3.2 metres
- Perfect for long sessions and anglers that like to fish from the boat
- Designed to be highly stable when on water even in trying conditions
- Heavy duty 0.9mm olive fabric
- Additional grab handles
- Fully adjustable rail seat
- Reinforced side and under rails for maximum protection
- Black oars supplied
- Square paddles for better performance
- Stainless front towing/anchor point
- Supplied with hard back for use with reinforced mounting points for engine and echo sounder
- Independent inflatable keel for stability
- Supplied with foot pump
- Two versions available – one supplied with independent green air deck (with easy access keel hole) and one with independent marine plywood floor with aluminium slats
- Fox Camo version now also available with marine ply floor

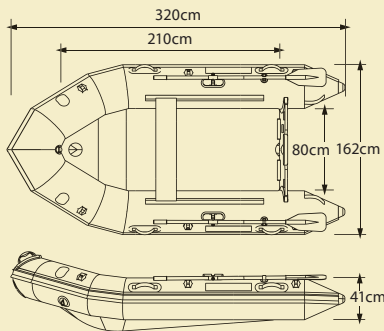

Packed Size: 112cm x 58cm x 32cm
 Weight: Air 49.7kgs/ Ply 64kgs
 Max Load: 560kgs
 Power: 15hp
 Packed Air Deck size: 95 x 50 x 10cm
 Air floor weight: 10.2kg
 Packed Ply Slat floor size: 110 x 32 x 14cm
 Weight: 24.6kg

SUPPLIED WITH

- Foot pump



		*RRP
CIB005	FX 320 Inflatable Boat (inc. Air Mattress Floor)	£1,049.99
CIB006	FX 320 Inflatable Boat (inc. Black Marine Ply Floor)	£1,049.99
CIB016	FX 320 Camo Inflatable Boat (inc. Black Marine Ply Floor)	NEW £1,199.99





Reinforced under rails



Solid back board



Stainless steel towing or anchor loop



Air mattress floor on green model



Reinforced carry handles

FX 290

- Highly versatile model that is perfect for a host of tasks such as rig placement, baiting up, landing fish and even fishing directly from
- Designed to be highly stable when on water even in trying conditions
- Heavy duty 0.9mm olive fabric
- Supplied with 2.9m green air mattress floor
- Additional grab handles
- Fully adjustable rail seat
- Reinforced side and under rails for maximum protection
- Black oars supplied
- Square paddles for better performance
- Stainless front towing/anchor point
- Supplied with hard back for with reinforced mounting points for engine and echo sounder
- Independent inflatable keel for stability
- Independent heavy duty fibrous air mattress with easy access keel hole
- Supplied with foot pump
- Fox Camo version now also available with marine ply floor

SUPPLIED WITH

- Foot pump

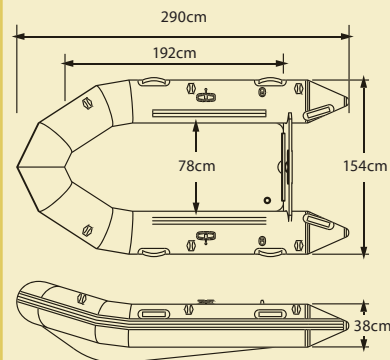

Packed Size: 110cm x 58cm x 35cm
 Weight: 40kgs
 Max Load: 510kgs
 Power: 10hp

CIB002	FX 290 Inflatable Boat (inc Air Mattress Floor)	*RRP £839.99
CIB015	FX 290 Camo Inflatable Boat (inc Black Marine Ply Floor)	NEW £974.99



Top quality row-lock



Marine ply floor

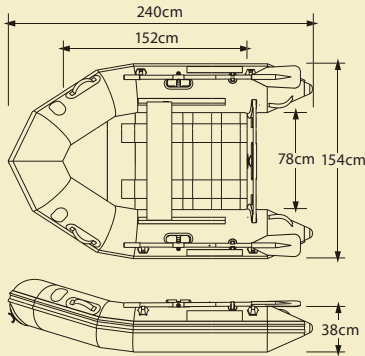

Packed Size: 105cm x 58cm x 32cm
 Weight: 32kgs
 Max Load: 240kgs
 Power: 5hp

FX240 FOX



Includes Footpump

FX 240

- A great all-rounder that is ideal for a host of jobs such as baiting up, rig placement, moving swims and landing fish
- Measure 2.4m long
- Heavy duty 0.9mm olive fabric
- Additional grab handles
- Fully adjustable rail; seat for maximum adjustability
- Reinforced side and under rails for maximum protection
- Black oars
- Square paddles for better performance
- Stainless front towing/anchor point
- Supplied with hard back for with reinforced mounting points for engine and echo sounder
- Marine ply floor (can be packed away assembled)
- Supplied with foot pump
- Fox Camo version also available

		*RRP
CIB004	FX 240 Inflatable Boat (inc. Slat Board Floor)	£599.99
CIB014	FX 240 Camo Inflatable Boat (inc. Hard Back Slat Floor)	£629.99



Reinforced rails for protection



Marine ply floor

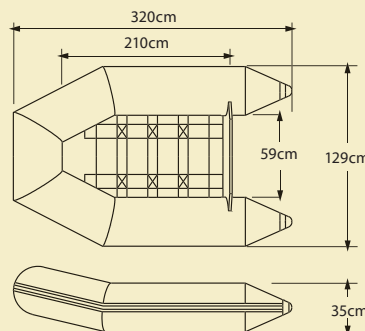

Packed Size: 110cm x 58cm x 35cm
 Weight: 22kgs
 Max Load: 200kgs
 Power: 2.2hp

FX200 FOX



Includes Footpump

FX 200

- Smallest of our FX range at 2m long
- Supplied with hard back for with reinforced mounting points for engine and echo sounder
- 0.7mm olive fabric
- Additional grab handles
- Fully adjustable rail seat
- Reinforced side and under rails for maximum protection
- Supplied with 2 x two piece black oars
- Stainless front towing/anchor point
- Marine ply floor (can be packed away with floor assembled)
- Supplied with foot pump
- Fox Camo version also available

		*RRP
CIB007	FX 200 Inflatable Boat (inc. Hard Back Marine Ply Floor)	£524.99
CIB013	FX 200 Camo Inflatable Boat (inc. Hard Back Slat Floor)	£574.99

FX PRO ELECTRIC OUTBOARD MOTORS

- Three sizes available – 35lb, 45lb and 55lb
- Aluminium shaft
- Quick release shaft with multiple angle fixings
- Battery drain on top
- All models are 12v
- Nylon reinforced brackets
- Polycarbonate propeller
- Aluminium motor housing
- 35lb model feature two blade propeller
- 45lb and 55lb models feature three blade propeller

		*RRP
CEN006	FX Pro 35lbs 2 Blade Prop	£199.99
CEN007	FX Pro 45lbs 3 Blade Prop	£219.99
CEN008	FX Pro 55lbs 3 Blade Prop	£239.99



Poly carbonate propellers



LED displays to easily see speed settings and battery life



Easy fit bracket

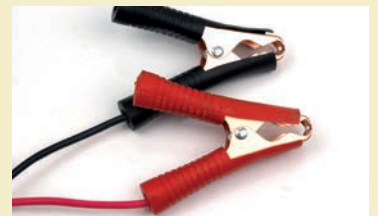

Quick release Crocodile clips

RECHARGEABLE AIR PUMP/DEFLATOR

- Battery-powered pump for inflating and deflating of boats
- 12v/240v
- Only supplied with European two prong plug socket



		*RRP
CIB003	Rechargeable Air Pump / Deflator	£39.99



BLACK LABEL™ LINE GUARDS

- Designed to screw onto banksticks/ stormpoles to keep mainline safe from weed/debris when Continental-style boat angling
- Two models available: C-Guard and Y-Guard
- Y-Guards are used to keep the line out of the water in a straight line, for example over a weedbed or debris in the margins
- C-Guards are used to adjust the angle of line around an obstacle, for example around marginal reeds/rushes. Or to create a safer line angle to the rod tip when fishing at extreme angles left or right
- Both features light reflective strip for easy location with head torch at night

		*RRP
CAC688	C-Line Guard	£9.99
CAC689	Y-Line Guard	£9.99





ROD SUPPORT

Like many of the product ranges produced here at Fox our offering for rod support is vast and detailed. The range covers a wide variety of angling situations ensuring that anglers across the globe have access to top quality products, designed specifically to do the job they require, regardless of the style of their carp angling.

Throughout the pages in this section you will find not only a variety of rod pod designs that cover small venues right through to the largest, most extreme waters; but also banksticks and buzz bars should you not be a rod pod user. In addition we also have a range of accessories such as back rests, snag ears and stabilisers to ensure the complete package is available!

Many of the tried and trusted products featured in the 2017 catalogue remain for 2018, simply because they are extremely popular and market leaders in their categories. We do have a few new additions however, such as the Black Label Complete 3-Rod Pod, some innovative snag ears with adjustable hockey sticks, plus some narrower Black Label buzz bars for those 'carpy' anglers who like to fish with their rods very close together.

SKY POD



The uniquely shaped body of the Sky Pod guarantees a solid set up with cam locks giving secure adjustment



Ergonomically designed thumb screws allow precise pitch adjustment of the buzz bars

Length Dimensions:
from 105cm to 205cm

Height Dimensions:
from 16.5cm to 94cm (short legs)
from 114cm to 192cm (long legs)

Width Dimensions:
76cm to 140cm (between long legs)

SKY POD® BUTT CAP



*RRP

RP3576 Sky Pod Butt Caps £7.99



SKY POD® - 3 ROD & 4 ROD

- Purposely engineered to give incredible stability when fishing on large continental lakes and big powerful rivers
- Body length adjustable to suit all standard rod lengths
- Adjustable leg splay
- Rods may be positioned anywhere from below the horizontal to almost the vertical plane
- Rear buzz bar can be positioned along the length of the body
- Profiled aluminium body and buzz bars guarantee a wobble-free set up
- Complete with FREE carry case
- Available in 3 or 4-rod versions

		*RRP
RP3573	Sky Pod 3-Rod and Carry Bag	£349.99
RP4006	Sky Pod 4-Rod and Carry Bag	£349.99

SUPPLIED WITH

- Free carry case





RANGER® MK2 POD - 3 ROD & 4 ROD

- One of the most versatile rod pods ever made!
- Unique leg locking mechanism – not required to fully unscrew the legs to change angle (only 2.5 rotations needed)
- Strong legs for reduced ‘flex’
- Legs have 6 angle positions for extreme versatility
- Ability to be converted from a standard Ranger Pod leg configuration to a Quad Pod configuration (4 legged tri-pod) by taking the legs from each end and moving them to the middle of the frame through the use of specially supplied shims
- Legs supplied measure 40cm, 45cm & 120cm
- 4 x Karabiner mounting points to tie/weigh down the pod
- Double Cam levers
- Black tubes and framework for extra stability
- All brass threaded fittings (no oxidation)
- Supplied with carry case that has a full length zip and large front storage pocket
- Perfect for all manner of terrains and venue types including the largest continental lakes and rivers
- 2-rod buzzer bars are available to purchase separately

		*RRP
CRP030	Ranger Mk2 Pod 3-Rod Kit	£289.99
CRP031	Ranger Mk2 Pod 4-Rod Kit	£309.99

- SUPPLIED WITH**
- Re-designed carry case



RANGER® MKII 2X BUZZ BARS

		*RRP
CRP032	Ranger Mk2 2-Rod Buzz Bars	£34.99

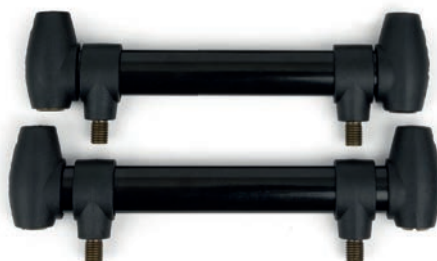

RANGER MKII



Six angle positions on legs for greater flexibility



Double tube framework for extra stability, which is fully adjustable



Can be converted into Quad Pod configuration by repositioning legs from both ends to the centre



Supplied with two 120cm extra long front legs for fishing at range

Length Dimensions:
from 82cm to 160cm (excluding legs)

HORIZON DUO



Carry bag has special storage for additional extra long legs



Four leg position angles make pod very versatile



Twin rail central aids stability and is also adjustable

Length Dimensions:
from 92cm to 168cm (excluding legs)



HORIZON® DUO POD - 3 ROD & 4 ROD

- Twin rail design gives extra stability
- Four leg position angles (allowing for rod tips to be pointing towards sky for long range fishing)
- Double Cam levers
- 2 x Karabiner mounting points to tie/weight down the pod
- All brass thread fittings (no oxidation)
- Rubber 'bumper' on 'head' moulding to protect your swinger head once it detaches from line and hits pod
- Standard leg lengths 33cm & 25cm
- 3-rod and 4-rod versions available
- Carry case as standard - incorporating; a full length zip and built in storage for additional XL legs. Carry case also has snag ear straps so they can be unscrewed off the buzzer bars and stored safely

		*RRP
CRP027	Horizon Duo 3-Rod Pod	£139.99
CRP028	Horizon Duo 4-Rod Pod	£149.99

SUPPLIED WITH

- Carry case



HORIZON® DUO OPTIONAL EXTRAS

- 2-Rod buzzer bars available separately.
- 36ins XL Legs (to allow the Euro style 'tips up' arrangement)

		*RRP
CRP029	Horizon Duo 2-Rod Buzz Bars	£34.99
CRP033	Horizon Duo 36ins Legs x 2	£29.99

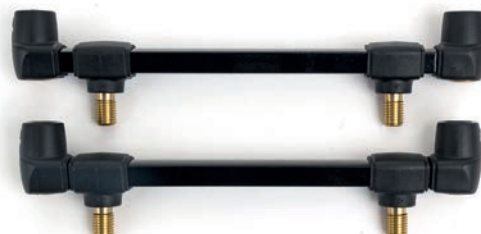



STALKER® POD PLUS

- One of Europe's biggest selling rod pods
- Lightweight aluminium tube frame is ideal for mobile and static angler alike
- Main central body is fully adjustable
- All four legs are extendable to aid the pods versatility and stability
- Supplied with both 2 and 3-rod buzz bars
- Three leg positions - forward, central and back
- Supplied with FREE carry case

		*RRP
CRP022	Stalker+ Pod	£99.99

STALKER PLUS+



Easy to adjust cams on the uprights make exact positioning of the buzz bars quick, easy and secure



The main body of both pods can be extended to suit different length rods and set-ups

SUPPLIED WITH

- Carry case
- x2 Rod buzz bars



X-POD®+

- Cost-effective pod that is sturdy, reliable and practical
- Scissor-action opening
- Low centre of gravity and goal post design makes this a very stable set up
- Fox Cam Lok fittings
- Complete with front and rear height adjustable banksticks measuring 30 and 25cm respectively
- Includes a pair of 3-rod Rod Lok buzz bars
- Adjustable length
- Ultra-lightweight and compact design



		*RRP
RP3495	X Pod Plus	£124.99

A-POD+™

- Based on same design as Stalker Plus pod but without the extending legs and two rod buzz bars
- Ideal for newcomers and anglers on tight budgets that still want Fox quality
- Extendable body
- Lightweight aluminium frame
- Three leg positions
- Supplied with 3-rod buzz bars
- Supplied with free carry case



SUPPLIED WITH

- Free carry case

		*RRP
CRP023	A-Pod Plus	£69.99



Precision moulded gears allow for compact pack down



Everything you need to create a 3-Rod Pod



NEW

BLACK LABEL™ - COMPLETE 3 ROD POD

- Contains all the items needed to create a fully setup 3-Rod Black Label Compact Rod Pod
- Kit comprises: 1x Compact Pod, 2x 6ins/15cm Cam Lok Banksticks, 2x 9ins/23cm Cam-Lok Banksticks, 1x pair of 3-Rod Fixed Buzz Bars and 1x Conversion Kit
- Perfect for anglers that fish on tough ground
- Supplied in neoprene protective case that stores all components and also features handy zipped compartment for storing bobbins etc

		*RRP
CRP035	Complete Pod 3 Rod Kit	£169.99

SUPPLIED WITH

- Protective neoprene case



Cam-Lok extensions and moulded leg blocks to secure banksticks in place



Precision moulded gears allow for compact pack down

Dimensions:
CENTRAL BAR - extends from 28cm-40cm
FOLDED DOWN - measures just 28cm x 11cm



BLACK LABEL™ COMPACT POD

- Eye-catching minimalist design that complements the Black Label bankware range
- Designed to work with standard Black Label Cam-Lok Banksticks
- Legs fold inwards around central bar making it very compact when packed away
- Adjustable legs allow pod to be adjusted for use with 2-Rod and 3-Rod Black Label Buzz Bars
- Central bar also adjustable to suit different lengths of rod
- Black anodised aluminium frame that only weighs 650g
- Precision moulded gears and Cam-Loks
- Supplied with protective neoprene case

		*RRP
CRP034	Black Label Compact Pod	£109.99

SUPPLIED WITH

- Protective neoprene case



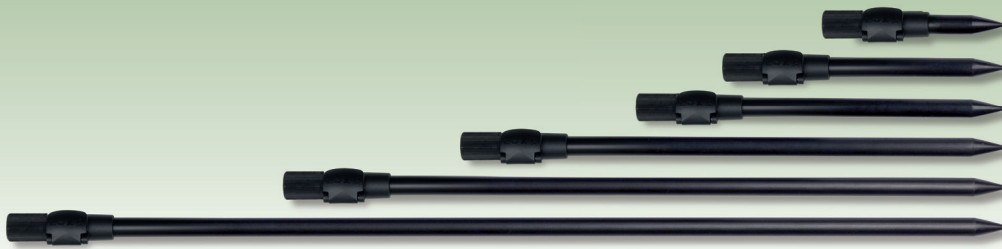

BLACK LABEL™ CAM LOK® BANKSTICKS

- Available in 6ins (15cm), 9ins (23cm), 12ins (30cm), 18ins (45cm), 24ins (60cm) and 36ins (90cm)
- Features Unique Fox Cam-Lok mechanism for strong grip when extended
- Works in conjunction with the new Black Label Compact Pod and all Black Label Buzz Bars
- Fits Black Label Stage Stand and Stabiliser perfectly
- Hardwearing anodised black coating
- Lightweight yet incredibly strong
- Packaging made from 100% recycled cardboard

		*RRP
CBS051	6ins/15cm Black Label Cam Lok Bankstick	£10.99
CBS041	9ins/23cm Black Label Cam Lok Bankstick	£12.99
CBS042	12ins/30cm Black Label Cam Lok Bankstick	£14.99
CBS043	18ins/45cm Black Label Cam Lok Bankstick	£16.99
CBS044	24ins/60cm Black Label Cam Lok Bankstick	£17.99
CBS045	36ins/90cm Black Label Cam Lok Bankstick	£19.99



BLACK LABEL™ CAM LOK® POWERPOINT® BANKSTICKS

- Available in 9ins (23cm), 12ins (30cm), 18ins (45cm), 24ins (60cm) and 36ins (90cm)
- Features Cam-Lok mechanism for strong grip when extended
- Supplied with T-bar for extra leverage when screwing into the toughest of ground
- Works in conjunction all Black Label Buzz Bars
- Strong, hardwearing and sharp Powerpoint spike on end for use on tough ground
- Hardwearing anodised black coating
- Lightweight yet incredibly strong
- CANNOT be used with Black Label Stage Stand, Stabiliser or Compact Pod
- Packaging made from 100% recycled cardboard

		*RRP
CBS046	9ins/23cm Black Label Cam Lok Powerpoint Bankstick	£14.99
CBS047	12ins/30cm Black Label Cam Lok Powerpoint Bankstick	£16.99
CBS048	18ins/45cm Black Label Cam Lok Powerpoint Bankstick	£18.99
CBS049	24ins/60cm Black Label Cam Lok Powerpoint Bankstick	£19.99
CBS050	36ins/90cm Black Label Cam Lok Powerpoint Bankstick	£21.99



BLACK LABEL™ ANGLE ADAPTOR

- Made from anodized aluminium
- Allows you to change angle of bite alarm or buzz bar but keep your bankstick straight
- Aids bite indication when fishing with high rod tips
- Perfect for anglers fishing at long range on large lakes and also great for river anglers
- Packaging made from 100% recycled cardboard

		*RRP
CBB018	Angle Adaptor	£10.99



BLACK LABEL™ SPACERS

- Designed to give bite alarms increased clearance above Black Label Buzz Bar
- Supplied with three in a pack
- Made from chunky, black anodised aluminium
- Fits all Black Label Buzz Bars
- Packaging made from 100% recycled cardboard

		*RRP
CBB010	Black Label Spacers x 3	£6.49



BLACK LABEL™ LEATHER WASHERS

- Give good purchase when tightening alarms to a bankstick/buzz bar or when screwing a buzz bar to a bankstick
- Harder wearing than rubber and also less likely to perish or stretch
- Four washers per pack
- Packaging made from 100% recycled cardboard

		*RRP
CBB006	Black Label Washers	£3.79



There are various 'fixed' models available



BLACK LABEL™ CONVERSION KIT

- Designed to transform ALL Black Label buzz bars into goal posts
- Allows Black Label buzz bars and banksticks to work with the new Black Label Compact Pod
- Comprises 4 x threads, 2 x blanking caps and 1 x Allen key
- Packaging made from 100% recycled cardboard

*RRP

CBB007	Black Label Conversion Kit	£6.99
--------	-----------------------------------	--------------

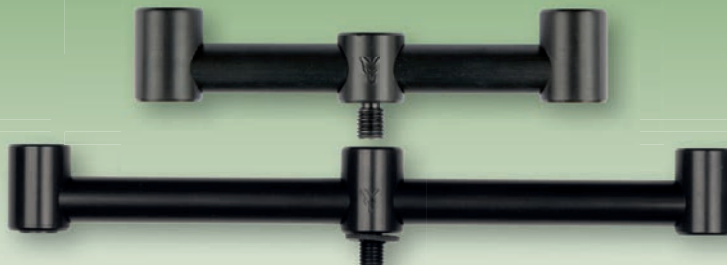

BLACK LABEL™ FIXED BUZZ BARS

- Designed to work with Conversion Kit to transform them into goal post set up (ideal for Black Label Compact Pod)
- Supplied with hardwearing leather washer to give good purchase when tightening to bankstick
- Two sizes available: 2-Rod (4.5ins back/5ins front) and 3-Rod (9ins back/10ins front)
- Central screw thread can be removed and replaced with a blanking cap when being used as a goal post setup
- Packaging made from 100% recycled cardboard

*RRP

CBB001	Black Label 2-Rod Fixed (Pair)	£29.99
CBB002	Black Label 3-Rod Fixed (Pair)	£34.99
CBB003	Black Label XL-Rod Fixed (Pair)	£37.99



NEW

BLACK LABEL™ NARROW FIXED BUZZ BARS

- New narrower version of our best-selling Black Label fixed Buzz Bars allow for a more compact look
- Available in 2-rod and 3-rod models
- Lightweight, anodised black aluminium
- Designed to work with Black Label Conversion Kit to transform them into goal post (ideal for the Black Label Compact Pod)
- Central screw thread can be removed and replaced with a blanking cap when being used as a goal post set up
- Supplied with a hard wearing leather washer to give good purchase when tightening to a bankstick
- Width: 2-rod 3.75in (95mm) rear and 4.3in (110mm) front, 3-rod 7.5in (190mm) rear and 8.6ins (220mm) front

*RRP

CBB019	Black Label 2-Rod Narrow (Pair)	£29.99
CBB020	Black Label 3-Rod Narrow (Pair)	£36.99



BLACK LABEL™ ADJUSTABLE BUZZ BARS

- Inner tube has a flat side to prevent rotating inside
- Collar and thread adjustment used instead of traditional thumb screw
- Designed to work with Conversion Kit to transform them into goal post set up (ideal for Black Label Compact Pod)
- Central screw thread can be removed when being used as a goal post setup
- Two sizes available: 2-Rod (4.5-6ins back, 5-7ins front) and 3-Rod (6-9ins back/7-10ins front)
- Supplied with hardwearing leather washer to give good purchase when tightening down to a bankstick
- Packaging made from 100% recycled cardboard

*RRP

CBB014	Black Label 2-Rod Adjustable (Pair)	£34.99
CBB004	Black Label 3-Rod Adjustable (Pair)	£49.99
CBB009	Black Label XL-Rod Adjustable (Pair)	£49.99



BLACK LABEL™ STABILISER

- Designed to prevent banksticks from spinning in soft ground
- Works with all standard banksticks in Black Label range (not Powerpoint)
- Chunky thumb screw secure stabiliser to bankstick and also looks the part
- Ideal for soft ground
- Packaging made from 100% recycled cardboard

		*RRP
CBS011	Black Label Stabiliser	£12.99



Stabiliser stops your bankstick spinning



The Stage Stand is ideal for platform swims

BLACK LABEL™ STAGE STAND

- Enables you to fish with banksticks on wooden platforms
- Chunky thumb screw for securing your bankstick firmly in position
- Screw supplied to secure stand to wood
- Works with Stage Stand Insert, standard Black Label Banksticks and Cam-Lock Black Label sticks (does not work with Powerpoint banksticks)
- Packaging made from 100% recycled cardboard

		*RRP
CBS012	Black Label Stage Stand	£15.99



BLACK LABEL™ STAGE STAND INSERT

- 3ins insert that allows your rod tips to be fished as close to waters surface as possible when fishing on wooden platforms
- Works perfectly with Black Label Stage Stand
- Lightweight black anodised aluminium
- Packaging made from 100% recycled cardboard

		*RRP
CBS013	Black Label Stage Stand Insert	£5.99



BLACK LABEL™ LINE GUARDS

- Designed to screw onto banksticks/stormpoles to keep mainline safe from weed/debris when Continental-style boat angling
- Two models available: C-Guard and Y-Guard
- Y-Guards are used to keep the line out of the water in a straight line, for example over a weedbed or debris in the margins
- C-Guards are used to adjust the angle of line around an obstacle, for example around marginal reeds/rushes. Or to create a safer line angle to the rod tip when fishing at extreme angles left or right
- Both features light reflective strip for easy location with head torch at night

		*RRP
CAC688	C-Line Guard	£9.99
CAC689	Y-Line Guard	£9.99



The Adjustable Hockey Stick allows you to change the tension of your indicator



Adjust the angle to adjust the tension



NEW

BLACK LABEL™ ADJUSTABLE HOCKEY STICK

- Injection moulded hard-wearing black plastic
- Adjustable stick allows you to set the tension you require from your bite indicator – simply screw your chosen cord, chain or quiver arm into place to lock the hockey stick in position

CBI118	Adjustable Hockey Stick	*RRP £4.99
--------	-------------------------	---------------



NEW

BLACK LABEL™ ADJUSTABLE HOCKEY STICK PLATE

- Machined black anodised plate with integrated adjustable hockey stick
- Adjustable stick allows you to set the tension you require from your bite indicator – simply screw your chosen cord, chain or quiver arm into place to lock the hockey stick in position
- Allows current owners of Black Label Snag Ears to upgrade to the adjustable hockey stick with minimal investment

CBB021	Adjustable Hockey Stick Plate	*RRP £13.49
--------	-------------------------------	----------------

NEW

BLACK LABEL™ SNAG EAR AND ADJUSTABLE HOCKEY STICK

- Machined black anodised plate with integrated adjustable hockey stick
- Adjustable stick allows you to set the tension you require from your bite indicator – simply screw your chosen cord, chain or quiver arm into place to lock the hockey stick in position
- Ears feature rubber overmould that offers protection to your rods
- Ears can be removed for transportation or if not required

CBB022	Snag Ear & Adjustable Hockey Stick	*RRP £18.49
--------	------------------------------------	----------------

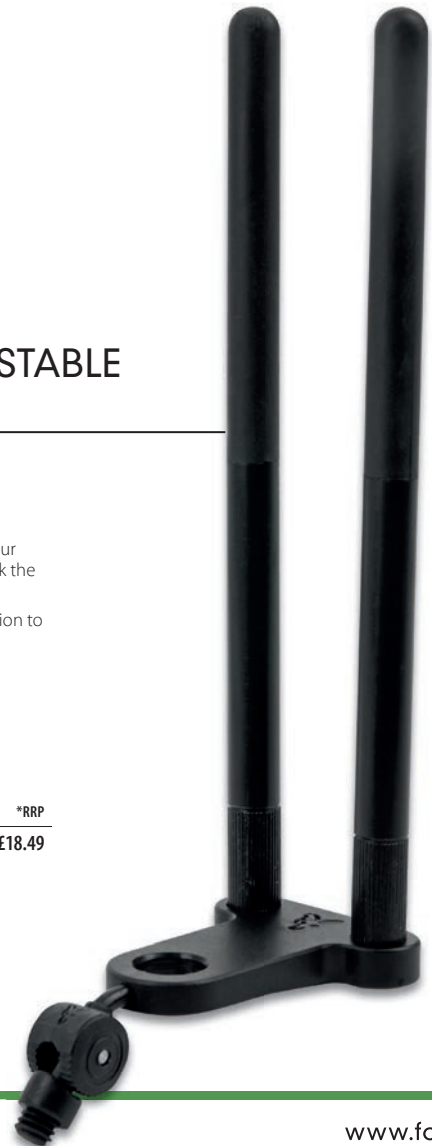

BLACK LABEL™ SNAG EARS

- Perfect for preventing rod from coming off alarm when snag fishing
- Ears can be unscrewed to protect them in transit or when they are not needed
- Rubber over moulds on the top half are designed to offer protection to your rod
- Designed to work with most bite alarms, especially our N and M series of Microns!
- Available in two sizes – standard and XL for fishing with rod tips high
- Packaging made from 100% recycled cardboard



		*RRP
CBB005	Black Label Snag Ears	£14.99
CBB008	Black Label XL Snag Ears	£15.99

BLACK LABEL™ SWINGER® PLATE SNAG EARS

- Built-in Swinger attachment on snag ear plate for easy alarm and Swinger alignment
- Designed for Fox Swingers to slide onto
- Ears can be unscrewed to protect them in transit or when they are not needed
- Rubber over moulds on the top half are designed to offer protection to your rod
- Designed to work with most bite alarms, especially our N and M series of Microns!
- Available in two sizes – standard and XL for fishing with rod tips high
- Packaging made from 100% recycled cardboard



		*RRP
CBB016	Black Label Swinger Plate Snag Ears	£17.99
CBB017	Black Label Swinger Plate Snag Ears XL	£19.99

BLACK LABEL™ HOCKEY STICK SNAG EARS

- Hockey stick built into snag ear plate for easy alarm and indicator alignment
- Designed for Black Label indicators to be screwed onto
- Ears can be unscrewed to protect them in transit or when they are not needed
- Rubber over moulds on the top half are designed to offer protection to your rod
- Designed to work with most bite alarms, especially our M series of Microns!
- Available in two sizes – standard and XL for fishing with rod tips high
- Packaging made from 100% recycled cardboard



		*RRP
CBB011	Black Label Hockey Stick Snag Ears	£15.99



Black Label Snag Ears in action



We make a range of butt grips to suit different butt sections



The Power Grip is ideal for fishing locked up



POWER GRIP BUTT REST

- Spring-loaded butt design gives exceptional grip for snaggy situations when you need to fish 'locked up'
- Simply place the butt of your rod between the two rubber rotating heads and it will lock into position.
- Heads grip the rod perfectly yet cause no damage to the blank

		*RRP
CBR004	Power Grip Butt Grip	£10.99



BUTT GRIPS

- Minimalist design
- Designed to be in contact with more of the rod butt's surface area than standard back rests allowing for a firmer grip
- Available in three sizes – Small for standard abbreviated handles, Medium for our Skinny Cork and Skinny Duplon and Large for traditional diameter cork and Duplon handles

		*RRP
CBR001	Small (Abbreviated handles)	£4.25
CBR005	Medium (Skinny Cork/Duplon handles)	£4.25
CBR002	Large (Full handles)	£4.25



BUTT REST

- Similar to our rear 'U' Rod Rest Head but an injection moulded version
- Compact design
- The tight grip is ideal for snag fishing
- Rod is released easily when lifted up

		*RRP
BB2692	Butt Rest	£3.49



REAR 'U' ROD REST HEAD

- Compact design that securely grips your rod butt
- The tight grip is ideal for snag fishing
- Rod is released easily when lifted up

		*RRP
BB7392	Rear 'U' Rod Rest Head	£4.99



DUO GRIP REST

- Injection moulded plastic rest
- Rubber inlays allow the rods to be locked solid for snag fishing
- Incorporates two betalight slots

		*RRP
BB5133	Duo Grip Rear Rest	£4.99



POD ANCHORS

- Designed to fit Ranger MK2, Horizon Duo, Stalker Plus and A-Pod
- Perfect for securing pod to wooden platform swims
- 4 Anchors per packet

		*RRP
RP5763	Pod Anchors x 4	£19.99

Powerpoint®

Cam Lok



CAM LOK® STORM POLE BANKSTICKS

- Powder coated aluminium storm poles which are ideal for use with Fox brollies
- Four sizes available
- All models extend to approximately 175% of their original length
- Feature patented Fox Cam Lok® mechanism
- Available in standard point and also Powerpoint® options

		*RRP
CBS019	Cam Lok 48in (120cm)	£14.99
CBS020	Cam Lok 36in (90cm)	£13.99
CBS021	Cam Lok 24in (60cm)	£12.99
CBS022	Cam Lok 16in (40cm)	£11.99
CBS023	Powerpoint® 48in (120cm)	£15.99
CBS024	Powerpoint® 36in (90cm)	£14.99
CBS025	Powerpoint® 24in (60cm)	£13.99
CBS026	Powerpoint® 16in (40cm)	£12.99



Removable tommy bars provide extra leverage for screwing banksticks into the ground



Banksticks are available as either Cam Lok® or Powerpoint® to penetrate the hardest ground

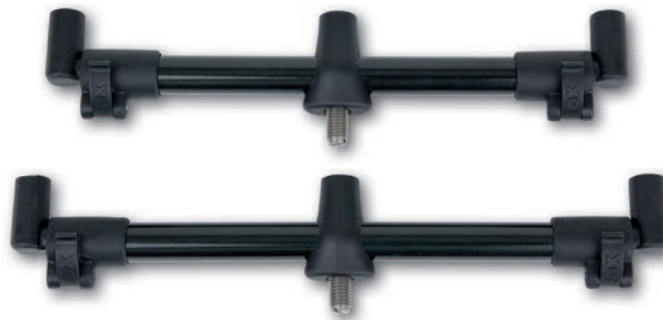

3 ROD EURO BUZZ BARS

- 3 Rod adjustable buzz bars
- Manufactured from 5/8" aluminium
- Supplied in pairs

		*RRP
BB7668	3-Rod Euro Buzz Bars	£31.99



CAPTIVE BACKLEADS MK2

- Allows angler to use heavy back lead and a tighter line and simply release when rod is lift up
- Mechanical gate latch designed for smooth line release
- Supplied on its own winder with 10m of highly visual orange cord
- Backlead clips onto winder for easy storage
- Winder can be attached to Captive Backlead Bar or pegged to ground via pegging hole

		*RRP
CBW001	1.25oz/35g	£8.99
CBW002	2oz/56g	£9.49
CBW003	3oz/85g	£9.99
CBW004	4oz/113g	£9.99
CBW005	5oz/142g	£10.99





CARP CARE

Caring for the fish that you have caught should be at the top of the list of priorities for any anglers. Here at Fox we take carp care very seriously and have a fully dedicated range of products that are designed to ensure the carp you catch are returned back to their home in the same condition as you caught them.

Within the carp care range we produce a number of products that enable you to land, unhook, weigh, retain, photograph and return your catches. Such is the high demand for these products the range from the 2017 catalogue remains the same for 2018 with the only new addition to share with you being our hugely popular Camolite Net Float...



Supplied with handy carry bag



50mm deep padding

Standard Dimensions:

Open size (internal): 108cm L x 50cm W x 15cm H
Packed size: 52cm L x 56cm W x 13cm H
Weight: 2.5kg

XL Dimensions:

Open size (internal): 119cm L x 66cm W x 18cm H
Packed size: 88cm L x 60cm W x 13cm H
Weight: 3.4kg



EASY MAT™

- Revolutionary design that has been copied by many but never bettered!
- Easy-to-use 'pop-up' frame design enables the mat to be assembled and packed away in a matter of seconds
- Flexible sides help to prevent your catch from flipping/sliding off the mat, yet due to their flexible nature they are fish-safe unlike many of the rigid, metal frame mats on the market
- Extremely well padded base (50mm foam) with fish-friendly finish
- Available in two sizes – Standard and XL
- Both sizes feature reinforced carry straps
- Carry bag supplied as standard
- Compact square shape when packed down makes this design barrow friendly

		*RRP
CCC033	Easy Mat Standard	£74.99
CCC034	Easy Mat XL	£84.99

EASY...



Velcro retaining straps and a handy zipped pocket for storing carp care essentials



Extra-thick padding with an easy clean mucus-friendly lining, to offer ultimate protection



DELUXE CARPMASTER® UNHOOKING MAT

- Designed to offer unrivalled padding and protection to your catch
- Reinforced, high sides with deep padding that prevent fish from sliding off of mat
- 80mm deep padding on base
- Easy clean mucus-friendly lining
- Reinforced webbing straps for more even weight distribution when carrying a fish to and from the water in the mat
- Stiffened EVA grab handles
- Zipped pocket on side for carp care kit, forceps and/or weighing scales
- Handy hanging loop for drying mat on bank or at home
- Dimensions: Standard L: 125cm x W: 65cm x H: 28cm, XL L: 138cm x W: 73cm x H: 28cm
- Folds away relatively compact considering depth of padding
- 100% Polyester

		*RRP
CCC029	Delux Carpmaster Cradle	£94.99
CCC031	Deluxe Carpmaster Cradle XL	£119.99



Mesh venting allows water to drain rapidly from the sling for accurate weighing



Ideal for retaining your catch for a short time while preparing camera equipment

STR FLOATATION WEIGH SLING

- Perfect for weighing your catch as well as retaining it for a short period whilst preparing photography (STR = Short Term Retention)
- Built around full-length floats, which support a lightweight, fish-friendly, soft nylon and mesh section
- Mesh section designed to maximise water exchange to ensure fish stays healthy
- Measures: 124cm L x 39cm W with a drop of 75cm
- Top mesh panel allows you to view fish at all times
- Zipped on three sides to allow sling to lay flat on your unhooking mat
- Full length double zips secured by a dog clip to ensure security
- Sculpted to house and fully support fish centrally during weighing
- Zip baffles to fully protect fish
- Double grab handles each end for safe lifting and carrying
- Reinforced stitching on all pressure points
- 3m heavy duty sack cord supplied in an external pocket
- Supplied in nylon sleeve / stink bag
- Mesh venting allows rapid water drainage for quick, accurate weighing
- Double weigh handles with centre locating loops
- Fox Camo version also available
- 100% Polyester

		*RRP
CCC035	Camo STR Floatation Weigh Sling	£59.99
CCC026	STR Weigh Sling	£49.99

ROYALE® CARP SACK

- Designed to ensure maximum protection and security when retaining a carp
- Fish-friendly soft mesh
- Measures 120cm x 80cm
- 4.8m long sack cord
- Single secure zip
- Rounded corners ensure carp cannot get their head trapped
- 100% Polyester



		*RRP
CCC032	Royale Carp Sack	£13.99

SAFETY CARP SACK

- Designed to ensure maximum protection and security when retaining a carp
- Measures 140cm x 100cm
- External zipped mesh pouch houses a high visibility Fox-moulded H-Block marker (with isotope recesses) on 10m of cord
- Unique sack cord system for enhanced bankstick security with 4m heavy duty cord
- Soft, dark, fish-friendly mesh
- Full length single zip with secure clip fastening
- Rounded corners ensure carp cannot get their head trapped
- Reinforced carry handles
- Supplied in a nylon carry pouch
- Polyester fabric, supplied in a nylon carry pouch



		*RRP
CCC027	Safety Carp Sack	£24.99



Folds up for easier transportation



Large weighing hook so easy to place weigh sling on it

WEIGHING TRIPOD

- Ideally suited to anglers that fish alone or need to weigh very large fish where extra support is needed in getting an accurate weight
- Two-piece legs with spigot in the middle to stop the legs from slipping under pressure from heavy fish
- Wide footprint aids stability
- Made from top quality, hardwearing steel frame
- Comes supplied with own carry bag



		*RRP
CCC037	Weighing Tripod	£39.99

DIGITAL SCALES

- Compact design
- Very user-friendly
- Simple, easy to use buttons
- Features on/off button to ensure maximum battery life
- Independently sealed electronics
- Simple zero button (0.00) which you press once you have attached your wet weigh sling
- Simply press the kg/lb button to select between kilograms or pounds
- Backlit screen for easy use in the dark
- Metal loop on top for use with a weigh bar or crook, or simply use your thumb for small fish
- Large weighing hook so easy to place weigh sling on it
- Low battery indicator
- Weighs up to 60kg (132lb) in 1oz increments
- Supplied with protective PU hard case
- Takes 2 x AA batteries



Back lit screen for use in the dark



Simple, easy to use buttons



		*RRP
CEI155	Digital Scales 60kg inc Case	£89.99

WEIGH BAR & CASE

- Dual purpose
- Bar comprises of 3 parts – two handle sections and the 'hook' section
- The two handles screw together with 'hook' in middle
- The bar can be used as a standard weigh bar for weighing fish or you can screw a pole onto the thread of the 'hook' section to create a weigh crook instead
- All three parts pack away into the neoprene carry case that is supplied



		*RRP
CCC036	Weigh Bar inc Case	£21.99

COLLAPSIBLE WATER BUCKET

- Perfect for keeping your catch wet when on the unhooking mat
- Welded PVC construction
- Collapsible design for compact storage
- Rigid top ring for easy filling
- 4.5 litre capacity
- Removable 1.6m drop cord with clip to aid filling when on high banks or if you suffer from a bad back
- Can also be used for cleaning hands, mixing groundbait etc



		*RRP
CCC040	Collapsible Water Bucket	£8.49



Perfect for keeping your catch wet on the bank



Collapsible design for compact storage

NEW

CAMOLITE™ NET FLOAT

- Features unique Fox Camo pattern
- Design to aid landing of fish
- Split design enables float to be used on nets with fixed spreader block such as Torque and Horizon XT
- Velcro closing and fastening



		*RRP
CLN035	Camolite Net Float	£9.99



Looks combined with practicality!



Soft mesh with reinforced corners



Machined aluminium spreader block



HORIZON® XT LANDING NET

- No expense spared on this top-of-the range landing net
- Highly versatile
- Unique spigoted handle design
- Complements the Horizon XT rod range
- Supplied with 6ft and 3ft handle options – 6ft for everyday use whilst 3ft is perfect for boat use
- The 3ft handle can also be added to 6ft one to create a 9ft handle for landing fish on Zig Rigs or from high swims
- Features a 1k carbon weave
- Japanese shrink wrap handle grip
- Black fittings
- Moulded solid aluminium spreader block that is bonded to a 6ins spigot and features a beta-light slot
- Carbon arms
- The deep mesh is reinforced on the corners, is incredibly soft and a nice carpy green colour
- Supplied with net bag
- Available in either 42 or 46ins

Handle options
3ft pole & 6ft pole supplied

		*RRP
CLN027	Horizon XT 42" Landing Net	£189.99
CLN028	Horizon XT 46" Landing Net	£199.99



SPARE REINFORCED MESH

- Soft green mesh
- Reinforced corner sections
- Designed to fit both Horizon XT and Torque models

		*RRP
CLN030	42" Landing Net Mesh	£19.99
CLN031	46" Landing Net Mesh	£22.99



FX NET STINK SLEEVE

- Available in standard and XL
- Fully welded seams to retain water and unpleasant smell
- Standard is designed to fit either a 42, 46 or 50ins landing net
- XL can hold two 42, 46 or 50ins landing nets or one of our STR Weigh Slings and a landing net
- Both feature a handy external pocket and Velcro strap for storing landing net pole, or even a stalking rod

		*RRP
CLU256	FX Net Stink Bag Sleeve	£12.99
CLU266	FX Net Stink Bag Sleeve XL	£16.99



TORQUE® LANDING NET

- Designed to match the Torque rod range
- Offers outstanding value for money
- One of the best-selling landing net ranges on the market
- Very light and easy to manoeuvre in the water
- 6ft and 8ft handle options available
- 8ft version features a two-piece handle that is ideal for boat fishing
- Japanese shrink wrap handle grip
- Moulded solid aluminium spreader block with a beta-light slot
- Carbon arms
- The deep mesh is reinforced on the corners, is incredibly soft and a nice green colour
- Supplied with net bag
- 6ft model available in either 42 or 46ins, 8ft version available 42ins

*RRP		
CLN025	Torque 42" Landing Net	£99.99
CLN026	Torque 46" Landing Net	£104.99
CLN032	Torque 42" 8ft 2 Piece Landing Net	£109.99



Machined aluminium spreader block



Soft mesh with reinforced corners

SPARE REINFORCED MESH

- Soft green mesh
- Reinforced corner sections
- Designed to fit both Horizon XT and Torque models

*RRP		
CLN030	42" Landing Net Mesh	£19.99
CLN031	46" Landing Net Mesh	£22.99

WARRIOR® S LANDING NET

- Designed to match the Warrior S carp rods
- Perfect for anglers operating on a tight budget that still want Fox quality
- Great build quality and regarded by many leading experts as the best net ever produced in its price bracket
- Unique Fox moulded spreader block
- Unbelievably light
- Matt black carbon handle with white graphics
- Shallow 70cm mesh
- Arms have a 90 degree angle on end to help protect the mesh
- Offers unrivalled value for money
- Supplied with net bag
- Available in either 42, 46 and new 50ins
- Warrior S Compact also available in 42ins with two-piece 6ft handle



*RRP		
CLN018	Warrior S 42" Landing Net	£69.99
CLN019	Warrior S 46" Landing Net	£74.99
CLN033	Warrior S 50" Landing Net	£84.99



Top quality plastic spreader block



Soft, fish-friendly shallow mesh

SPARE MESH

- Soft black mesh
- Designed for Warrior S landing nets

*RRP		
CLN020	Warrior S 42" Spare Mesh	£17.99
CLN021	Warrior S 46" Spare Mesh	£19.99
CLN034	Warrior S 50" Spare Mesh	£22.99





TACKLE & RIG STORAGE

One of the keys to being a consistently successful carp angler is organisation. This organisation comes in many forms and one area where it is paramount is in tackle and rig storage. At Fox we are firm believers that an organised carp angler is a better angler.

Cliff Fox was one of the original pioneers when it came to designing and manufacturing dedicated items to enable anglers to organise their tackle and rig in a more efficient manner. All these years later here at Fox we are still striving to provide you, the angler, with the very best items for the job in hand. Over the coming pages you will find various tackle boxes that suit all manner of budgets and requirements plus some handy rig storage items for all manner of rigs including purpose-designed storage for Chod, Zig and floater fishing rigs.

Finally we have a brand-new storage item that premieres in this catalogue. The F-Box Hook Storage boxes have been designed to meet the requirements of the modern carp angler who likes to keep their pin-sharp hooks stored in a way that each individual hook is secured in place and cannot come into contact with other hooks or packaging that may damage those ultra-fine points.

F BOX® & DELUXE F BOX

The ultimate in ready-made storage solutions F Box Deluxe boxes are supplied with a variety of different F Boxes and spool dispensers so you have a comprehensive storage system to accommodate all of your tackle items.

The whole range is also totally integrated with our highly popular Camolite, Royale and Voyager luggage ranges so you can be sure you'll find the perfect pocket to put them in to get them safely to your swim too. F Boxes include all of the same features as the F Box Deluxe but are supplied without additional storage boxes so you can tailor storage to your own individual requirements.



F BOX® LARGE DOUBLE

- Deep partition large x4
- Deep partition medium x4
- Deep partition small x8
- Shallow partition large x4
- Shallow partition medium x4
- Shallow partition small x4

CBX005 F Box Double Large Box *RRP
£39.99



F BOX® MEDIUM DOUBLE

- Deep partition large x4
- Deep partition medium x3
- Deep partition small x3
- Shallow partition large x4
- Shallow partition small x4

CBX006 F Box Double Medium Box *RRP
£34.99



F BOX® LARGE SINGLE

- Deep partition large x4
- Deep partition medium x4
- Deep partition small x8

CBX007 F Box Large Box *RRP
£34.99



F BOX® MEDIUM SINGLE

- Deep partition large x4
- Deep partition medium x3
- Deep partition small x3

CBX008 F Box Medium Box *RRP
£22.99



F BOX® DELUXE LARGE DOUBLE

- Deep partition large x 4
- Deep partition small x 8
- Shallow partition medium x 4
- 8 compartment x 2
- 2 compartment x 1
- 4 compartment shallow x 1
- Rig boards x 2
- Deep partition medium x 4
- Shallow partition large x 4
- Shallow partition small x 4
- 4 compartment x 1
- 8 compartment shallow x 1
- Spool dispensers x 5
- Flip top x 2



CBX001 F Box Deluxe Set - Large Double *RRP
£84.99

F BOX® DELUXE MEDIUM DOUBLE

- Deep partition large x4
- Deep partition small x3
- Shallow partition small x4
- 6 compartment x1
- 8 compartment shallow x1
- Spool dispensers x2
- Deep partition medium x3
- Shallow partition large x4
- 8 compartment x1
- 4 compartment x1
- 4 compartment shallow x1
- Flip top x2



CBX002 F Box Deluxe Set - Medium Double *RRP
£64.99

F BOX® DELUXE LARGE SINGLE

- Deep partition large x4
- Deep partition small x8
- 4 compartment x1
- Spool dispensers x5
- Flip top x2
- Deep partition medium x4
- 8 compartment x2
- 2 compartment



CBX003 F Box Deluxe Set - Large Single *RRP
£74.99

F BOX® DELUXE MEDIUM SINGLE

- Deep partition large x4
- Deep partition small x3
- 4 compartment x1
- Flip top x2
- Deep partition medium x3
- 8 compartment x1
- Spool dispensers x2



CBX004 F Box Deluxe Set - Medium Single *RRP
£44.99

F BOX® COMPARTMENT BOXES

- Perfect for storing a whole variety of rig bits including swivels, beads, clips, boilie stops, sinkers, Zig Alignas, foam, cork, line alignas etc
- Modular design
- Fits perfectly into F Box and Royale tackle boxes
- Contents remain visible
- Secure clips
- Easy to remove contents
- Available in 8, 6, 4 and 2 compartment options



8 COMPARTMENT



6 COMPARTMENT



4 COMPARTMENT

		*RRP
CBX015	F Box 2 Compartment	£7.49
CBX011	F Box 4 Compartment	£7.49
CBX028	F Box 6 Compartment	£7.49
CBX009	F Box 8 Compartment	£7.49



NEW

Hooks not included

F BOX® HOOK STORAGE

- Purpose-designed storage system for keeping your hooks protected and organised
- Moulded rubber insert holds each hook individually to ensure the point cannot be damaged in transit
- Supplied with self-adhesive identification labels that allow you to record pattern and size of hooks inside
- Designed to fit neatly inside F-Box and Royale tackle boxes
- Will accommodate hooks from size 2-10
- Two sizes available: Large (holds 18 hooks) and XL (holds 29 hooks)
- Two boxes per pack



Handy self adhesive labels for easy identification

		*RRP
CBX075	Hook Storage Cases Large x2	£6.99
CBX076	Hook Storage Cases XL x2	£7.99



Handy built-in storage compartment for unused rig pins (50 pins supplied)

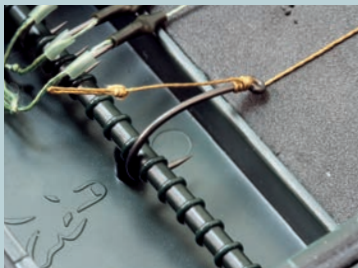

Profiled hook bars help to stop your rigs from sliding and bunching together



Massive storage capacity compared to other devices of similar proportions



Rigs not included

F BOX® RIGID RIG CASE

- Innovative design ensure maximum use of internal storage space
- Double-sided hinged middle section that is removable. This is designed to allow you to wind and store long rigs such as Zigs and floater fishing hooklinks around it
- Rounded ends on middle section maintain curvature in tubing on eye of hook
- Perfect for storing a wide variety of rigs
- High density EVA foam ensures pins hold in place securely
- Profiled hook bars stop rigs from sliding and bunching together
- Built-in storage compartment for rig pins (50 pins supplied)
- Moulded ruler on lid for accurate rig tying
- High impact ABS outer shell
- Waterproof rubber seal
- Dimensions: L 35cm x W 10cm x H 7cm
- Massive storage capacity compared to other devices of similar proportions
- Rounded ends on middle section maintain curvature in tubing and allow Zig Rigs to be wrapped around

		*RRP
CBX069	F Box Rig Case System inc 50 pins	£24.99

ROYALE® SYSTEM BOX

- Perfect for storing your rig and accessory items
- Removable dividers allow you to change size of compartments
- Medium supplied with: 4 Compartment Box, 2 Compartment Box, 4 x Flip Top 4 Compartment Box, Rig Board and Spool Dispenser
- Large supplied with: 8 Compartment Box, 2 Compartment Box, 4 Compartment Box x2, Flip Top 4 Compartment Box x4, Rig Board, Spool Dispenser x2
- Styled in a carpy green
- Designed to fit Royale, Camolite and FX luggage



		*RRP
CBX067	Royale Loaded Box Medium	£27.99
CBX068	Royale Loaded Box Large	£39.99

STEAM AND STORE CHOD/WITHY BIN

- Purposely designed for aiding the tying and storing of Chod and Withy Pool rigs
- Self-contained within a compact and secure screw-topped and tinted green storage tub
- Features three different diameter sections that allow you to select the degree of curve that best suits you
- Simply place your Chod or Withy Pool Rig on your chosen section and then steam it over a boiling kettle to help set the perfect curve
- Rigs can be stored on device until they are needed
- Supplied with 20 specially designed pins that allow you to put stiff rig loops under tension without them losing their shape



		*RRP
CAC377	Steam and Store Chod/Withy Bin	£14.99

MULTI CHOD & ZIG BIN

- Purpose-designed for storage of Chod and Zig Rigs
- Also helps you when tying Chod and Zig Rigs
- Supplied with six discs in total – two of each size
- Largest disc is perfect for storing Zig Rigs, also helps to measure the length as 1 wrap is 1/2ft therefore 2 wraps of the disc = 1ft
- The discs can be removed from the main shaft and further discs are available to purchase separately meaning you can customise the bin to have the sizes of disc you prefer
- Can also be used to help steam the perfect curve in your Chod Rigs too
- Supplied with 18 pins
- Discs also available to buy separately – two discs per packet + 6 pins per packet



		*RRP
CAC656	Multi Chod and Zig Bin inc. 18 pins	£10.99
CAC657	Chod Disc Small inc 6 pins x 2	£3.49
CAC658	Chod Disc Medium inc 6 pins x 2	£3.49
CAC659	Chod Disc Large inc 6 pins x 2	£3.49



Rigs not included

ZIG DISC

- Purposely designed for Zig Rig storage
- Also ideal for surface fishing hooklinks
- Supplied with five, removable high density foam discs
- Discs can be removed from the central bar and have a circumference of 1ft (30cm), which makes it very easy to tie the perfect length Zig every time
- Supplied with 20 rig pins which are stored in the handle
- Comes supplied in a handy neoprene zip case that keeps your rigs protected in transit

		*RRP
CAC498	Zig Disc Storage System	£17.99

HOW IT WORKS...



Start by placing your hook into the foam groove on a Zig Disc



Now wind the hooklink around the disc – every wrap is 1ft



When you have got your desired length simply cut the hooklink



Tie a figure-of-eight in the end and pin the hooklink in place





ACCESSORIES

What you are about to encounter over the coming pages can only be described as one of the most comprehensive ranges of carp fishing accessories that you are likely to find anywhere on the planet! All of the tackle developed at Fox is designed by carp anglers for carp anglers and as a result our team do not like to leave any base uncovered. This means that no matter what style of carp fishing you like to do you are sure to find the correct range of accessories within this section to perfectly aid your angling.

In recent years our Edges range of end tackle has firmly established itself as one of, if not the most popular on the market. The level of detail that has been applied to the Edges range is unrivalled of that we are in no doubt and if you are a carp angler that is trying to stay one step ahead of other anglers and the carp then we strongly recommend you start incorporating Edges into your armoury! Those of you that are already fans of Edges will be pleased to hear we have some interesting new additions in the range that can be found in this section including a host of ready-tied rigs plus some new hooklink materials.

In addition to the vast Edges terminal tackle range you will also find a number of other accessories in this section including baiting tools, leads, PVA, Zig Rig floats, Arma Mesh and feature finding tools.



NEW

CURVE SHORT RIGS

- Constructed from Edges Coretex Matt coated braid with loop in end for use with quick change swivels
- Featuring Edges Curve Short hooks
- Breaking strain matches hook size: 15lb (6.8kg) with size 8 hook, 20lb (9.07kg) in size 6 and 25lb (11.3kg) for size 4 and 2
- Also feature Trans Khaki Anti-Tangle Sleeves, Trans Khaki Line Aligna Adaptor and Trans Khaki Hook Silicone on Hair
- Supplied with 2 x size 7 Swivels, 2 x size 7 Kwik Change Swivels and FREE Hair Extending Boilie Props
- 2 rigs per packet
- Micro Barbed-only
- Available in Weedy Green or Gravelly Brown



NEW

WIDE GAPE RIGS

- Constructed from Edges Coretex Matt coated braid with loop in end for use with quick change swivels
- Featuring Edges Wide Gape Beaked hooks
- Breaking strain matches hook size: 15lb (6.8kg) with size 8 hook, 20lb (9.07kg) in size 6 and 25lb (11.3kg) for size 4 and 2
- Also feature Trans Khaki Anti-Tangle Sleeves, Trans Khaki Line Aligna Adaptor and Trans Khaki Hook Silicone on Hair
- Supplied with 2 x size 7 Swivels, 2 x size 7 Kwik Change Swivels and FREE Hair Extending Boilie Props
- 2 rigs per packet
- Micro Barbed and Barbless options available (Barbless only available in hook sizes 6 and 8)
- Available in Weedy Green or Gravelly Brown



NEW

CHOD RIGS

- Constructed from Edges Rigidity Trans Khaki stiff monofilament
- Featuring Edges Stiff Rig Beaked hooks
- Breaking strain matches hook size: 25lb (11.3kg) for sizes 6, 7 and 8 and 30lb (13.6kg) for sizes 4 and 5
- Also feature Edges Micro Hook Ring Swivel on the D for mounting hookbait onto and a size 11 Flexi Ring Swivel
- Supplied on foam discs that can be loaded straight into your Multi Chod & Zig Bin
- 3 rigs per packet
- Micro Barbed and Barbless options available (Barbless only available in hook sizes 6 and 8)
- Available in Standard and Short sizes



NEW

WIDE GAPE PVA BAG RIGS

- Constructed from Edges Reflex Camo Braid in Light Camo with a loop in end for use with quick change swivels
- Featuring Edges Wide Gape Beaked hooks
- Breaking strain matches hook size: 15lb (6.8kg) with size 6 and 8 hook, 25lb (11.3kg) for size 4
- Also feature Trans Khaki Micro Line Aligna Adaptor and Trans Khaki Hook Silicone on Hair
- Supplied with 2 x size 7 Flexi Ring Swivels, 2 x size 7 Kwik Change Swivels, 2 x Trans Khaki Micro Anti-Tangle Sleeves and FREE Hair Extending Boilie Props
- 2 rigs per packet
- Micro Barbed and Barbless options available (Barbless only available in hook sizes 6 and 8)





LEAD CLIP 30LB SUBMERGE LEADERS + K/C KIT

- Three 75cm lengths of Edges 30lb Submerge lead-free leader
- All three leaders have Trans Khaki Lead Clip and Tail Rubber in place
- Supplied with standard and Kwik Change swivel options
- Spliced loops at both ends so swivels can be changed via simple loop-to-loop connection
- Allows you to loop-to-loop straight to the swivel on one of our ready-tied rigs
- Available in Weedy Green and Gravelly Brown

CAC625 Lead Clip 30lb Submerge Leaders K/C Green
CAC626 Lead Clip 30lb Submerge Leaders K/C Brown



30LB SUBMERGE HELI RIGS LEADERS + K/C KIT

- Three 75cm lengths of Edges 30lb Submerge lead-free leader
- All three leaders have Edges Trans Khaki helicopter rig components setup in place
- Features 3 x Heli Buffer Sleeves, 3 x 6mm Tapered Bore Bead, 3 x length 0.5mm Leader Silicone
- Supplied with 3 x Flexi Ring Swivel plus 3 x Kwik Change Flexi Ring Swivels
- Spliced loops at both ends so swivels can be changed via simple loop-to-loop connection
- Allows you to loop-to-loop straight to the swivel on one of our ready-tied rigs
- Available in Weedy Green and Gravelly Brown

CAC627 30lb Submerge Heli Rigs with K/C Green
CAC628 30lb Submerge Heli Rigs with K/C Brown



LEADCORE HELI RIGS + K/C KIT

- Three 75cm lengths of Edges Camo Leadcore
- All three leaders have Edges Trans Khaki helicopter rig components setup in place
- Features 3 x Heli Buffer Sleeves, 3 x 6mm Tapered Bore Bead, 3 x length 0.5mm Leader Silicone
- Supplied with 3 x Flexi Ring
- Swivel plus 3 x Kwik Change Flexi Ring Swivels
- Spliced loops at both ends so swivels can be changed via simple loop-to-loop connection
- Allows you to loop-to-loop straight to the swivel on one of our ready-tied rigs
- Available in Light or Dark Camo

CAC573 Leadcore Heli Rigs + KC Kit Light Camo
CAC574 Leadcore Heli Rigs + KC Kit Dark Camo

SUBMERGE LEADERS + K/C KIT

- Three 75cm lengths of Edges 30lb Submerge lead-free leader
- Supplied with three swivel options – standard, Flexi Ring and Kwik Change
- Spliced loops at both ends so swivels can be changed via simple loop-to-loop connection
- Allows you to loop-to-loop straight to the swivel on one of our ready-tied rigs
- Available in Weedy Green or Gravelly Brown

CAC580 Submerge Leaders + KC Kit - Green 30lb
CAC581 Submerge Leaders + KC Kit - Brown 30lb



LEADCORE LEADERS + K/C KIT

- Three 75cm lengths of Edges Camo Leadcore
- Supplied with three swivel options – standard, Flexi Ring and Kwik Change
- Spliced loops at both ends so swivels can be changed via simple loop-to-loop connection
- Allows you to loop-to-loop straight to the swivel on one of our ready-tied rigs
- Available in Light or Dark Camo

CAC577 Leadcore Leaders + KC Kit Light Camo
CAC578 Leadcore Leaders + KC Kit Dark Camo



LEAD CLIP LEADCORE LEADERS + K/C KIT

- Three 75cm lengths of Edges Camo Leadcore
- All three leaders have Trans Khaki Lead Clip and Tail Rubber in place
- Supplied with standard and Kwik Change swivel options
- Spliced loops at both ends so swivels can be changed via simple loop-to-loop connection
- Allows you to loop-to-loop straight to the swivel on one of our ready-tied rigs
- Available in Light or Dark Camo

CAC575 Lead Clip Leadcore Leaders + KC Kit Light Camo
CAC576 Lead Clip Leadcore Leaders + KC Kit Dark Camo



LEAD CLIP TUBING RIGS + K/C KIT

- Three 75cm lengths of Edges Camo Leadcore
- Supplied with three swivel options – standard, Flexi Ring and Kwik Change
- Spliced loops at both ends so swivels can be changed via simple loop-to-loop connection
- Allows you to loop-to-loop straight to the swivel on one of our ready-tied rigs
- Available in Light or Dark Camo

CAC579 Lead Clip Tubing Rigs + KC Kit - Trans Khaki





Long needle sharp straight points

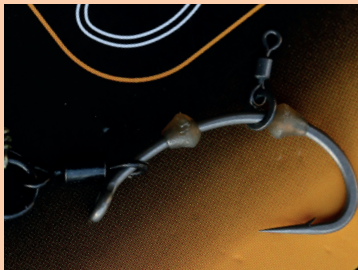

Curve Medium is perfect 360 Rigs

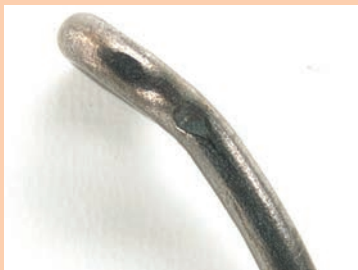

Strong XC80 Vanadium forged steel

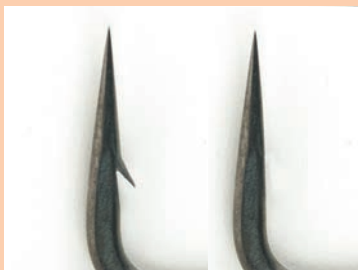

Micro barbed and barbless options



EDGES® CURVE SHANK

- Improved version of the original Arma Point SSC design
- Especially suited to bottom bait and wafter presentations
- Utilizes Arma Point technology
- Needle-sharp straight point
- Inturned eye
- Aggressive curved shank helps the hook to turn and grab hold in the fish's mouth
- Non-reflective dark coating
- Super-strong yet lightweight XC80 Vanadium forged steel construction
- Barbed sizes available: 2, 4, 5, 6, 7 & 8
- Barbless size available: 6 & 8
- 10 per packet



EDGES® CURVE SHORT

- Improved version of the original Arma Point XSC design
- Perfect for both bottom bait and pop-up presentations
- Utilizes Arma Point technology
- Needle-sharp straight point
- Straight eye
- Short, sweeping shank
- Non-reflective dark coating
- Super-strong yet lightweight XC80 Vanadium forged steel construction
- 10 per packet
- Only available in Barbed
- Sizes available: 2, 4, 5, 6, 7 & 8



EDGES® CURVE MEDIUM

- Perfect for both bottom bait and pop-up presentations
- Ideally suited for the popular 360 Rig presentation
- Utilizes Arma Point technology
- Needle-sharp straight point
- Inturned eye
- Aggressive medium-length curved shank helps the hook to turn and grab hold in the fish's mouth
- Non-reflective dark coating
- Super-strong yet lightweight XC80 Vanadium forged steel construction
- Barbed sizes available: 2, 4, 5, 6, 7 & 8
- Barbless size available: 6 & 8
- 10 per packet



EDGES® WIDE GAPE STRAIGHT

- Perfect for both bottom bait and pop-up presentations
- Utilizes Arma Point technology
- Long, needle-sharp straight point
- Aggressive 25 degree inturned eye
- Non-reflective dark coating
- Super-strong yet lightweight XC80 Vanadium forged steel construction
- Barbed sizes available: 2, 4, 5, 6, 7 & 8
- Barbless size available: 6 & 8
- 10 per packet



EDGES® WIDE GAPE BEAKED

- Improved version of the original Arma Point SSBP design
- Perfect for both bottom bait and pop-up presentations
- Utilizes Arma Point technology
- Needle-sharp beaked point
- Beaked point makes hook perfect for bottom bait fishing on hard gravel lakebeds
- 10 degree inturned eye
- Non-reflective dark coating
- Super-strong yet lightweight XC80 Vanadium forged steel construction
- Barbed sizes available: 2, 4, 5, 6, 7 & 8
- Barbless size available: 6 & 8
- 10 per packet



EDGES® STIFF RIG BEAKED

- Improved version of the original Arma Point SR design
- Perfect for pop-up presentations such as Chod, Hinged Stiff and Multi rigs
- Also suited to bottom bait stiff rig presentations
- Utilizes Arma Point technology
- Needle-sharp beaked point
- 25 degree outturned eye for use with super-stiff mono such as Edges Rigidty
- Large eye allows 30lb Rigidity to pass through three times if attaching with knotless knot
- Non-reflective dark coating
- Super-strong yet lightweight XC80 Vanadium forged steel construction
- Barbed sizes available: 2, 4, 5, 6, 7 & 8
- Barbless size available: 6



EDGES® STIFF RIG STRAIGHT

- Designed to meet the demands of anglers that prefer straight pointed hooks
- Perfect for pop-up presentations such as Chod, Hinged Stiff and Multi rigs
- Also suited to bottom bait stiff rig presentations
- Utilizes Arma Point technology
- Needle-sharp straight point
- 25 degree outturned eye for use with super-stiff mono such as Edges Rigidty
- Large eye allows 30lb Rigidity to pass through three times if attaching with knotless knot
- Non-reflective dark coating
- Super-strong yet lightweight XC80 Vanadium forged steel construction
- Barbed sizes available: 2, 4, 5, 6, 7 & 8
- Barbless size available: 6 & 8
- 10 per packet



EDGES® ZIG & FLOATER HOOKS

- Designed specifically for use on Zig and surface rigs
- Also suited to bottom bait stiff rig presentations when scaling down is required
- Utilizes Arma Point technology
- Needle-sharp straight point
- Slightly outturned eye for use with monofilament hooklinks
- Non-reflective dark coating
- Super-strong yet lightweight XC80 Vanadium forged steel construction
- Finer wire gage compared to other Edges hooks due to the delicate presentations they are designed for
- Barbed sizes available: 6, 8 & 10
- Barbless size available: 6, 8 & 10
- 10 per packet



Long, needle-sharp beaked points



25 degree outturned eye on Stiff Rig patterns



Stiff Rig patterns ideal for Chod & Multi Rigs



Finer wire on Zig & Floater pattern



NEW



CORETEX™ TUNGSTEN

- Features unique tungsten impregnated outer coating
- Soft, supple, sinking braid inner
- Tungsten coating helps to pin hooklink to lakebed
- Coating is strippable for creation of combi rigs
- Two tone colouring for camouflage
- Available in 20lb and 35lb breaking strains
- 20m per spool



NEW

CAMO-SPLICE

- Spliceable braided hooklink
- Very supple and dense allowing it to pin to the lakebed
- Camouflage colour
- Ideal for creating multi-rigs and splicing hooks/swivels directly onto the hooklink, keeping them clear neat and tidy without knots
- We recommend to use the Easy-Splice Needle with this material
- Available in 50lb breaking strain
- 20m per spool



CAMOTEX™ STIFF

- Ultra-soft, coated braid perfect for bottom bait and pop-up rigs
- Could be mistaken for a normal uncoated braid such is its softness
- Coating and inner braid features colour break camouflage pattern
- Easy to strip outer coating
- Available in two colour options – Light Camo and Dark Camo
- Breaking strains – 15lb (6.8kg), 20lb (9kg), and 25lb (11.3kg)
- 20m on a spool

CAMOTEX™ SOFT

- Ultra-stiff coated braid that is perfect for bottom bait and pop-up rigs
- Coating and inner braid both feature colour break camouflage pattern
- We recommend you remove outer coating before tying a knot in this material as it is so stiff the coating could break when knotting
- Has great anti-tangle properties
- Steams very straight making it great for stiff rigs and boom sections on Hinged Stiff Rig
- Easy to strip outer coating
- Available in two colour options – Light Camo and Dark Camo
- Breaking strains – 15lb (6.8kg), 20lb (9kg), and 25lb (11.3kg)
- 20m on a spool



CAMOTEX™ SEMI-STIFF

- Semi-stiff coating that sits in between the Camotex Stiff and Camotex Soft
- Perfect for bottom bait and pop-up rigs
- Coating and inner braid both feature colour break camouflage pattern
- We recommend you remove outer coating before tying a knot in this material as it is so stiff the coating could break when knotting
- Steams very straight
- Has great anti-tangle properties
- Easy to strip outer coating
- Available in two colour options – Light Camo and Dark Camo
- Breaking strains – 15lb (6.8kg), 20lb (9kg), 25lb (11.3kg) and new 35lb (15.8kg)
- 20m on a spool

CORETEX™ MATT

- Based on original Coretex but with an improved matt coating to reduce glare in water
- Perfect for a wide variety of rig presentations
- Semi-stiff coating aids anti-tangle properties and allows for combi rig presentations to be created
- Easy to strip outer coating
- Available in Weedy Green and Gravelly Brown
- Breaking strains – 15lb (6.8kg), 20lb (9kg), 25lb (11.3kg) and 35lb (15.8kg)
- 20m on a spool



REFLEX™ CAMO

- Designed to be better than any other braided hooklinks currently available
- Features colour break camouflage pattern
- Very supple braided hooklink material that is ideal for use in Rapide PVA bags
- Sinks without need for putty
- Available in two colour options – Light Camo and Dark Camo
- Breaking strains available are 15lb (6.8kg), 25lb (11.3kg) and 35lb (15.8kg)
- 20m per spool

RIGIDITY® TRANS KHAKI

- Improved version of the original Rigidity
- Features Trans Khaki camouflage for low visibility
- Stiffest Chod filament we have ever seen
- Perfect for Chod and Hinged Stiff Rigs
- Stiff nature makes it very hard for a carp to eject once it has been sucked in
- Whipping knot needs to be used with 30lb version
- Available in two breaking strains 25lb (11.3kg) and 30lb (13.6kg)
- Supplied on 30m spoils!

ILLUSION® TRANS KHAKI SOFT HOOKLINK

- Improved Illusion hooklink that features our revolutionary Trans Khaki camouflage
- Perfect for gin clear venues
- The most invisible hooklink Rob Hughes has ever dived over
- Fast sinking and supple
- High abrasion resistance and low stretch
- Great knot strength
- Perfect for a whole host of rig presentations
- Supplied on 50m spoils
- Available in 12lb (5.45kg) and 15lb (6.8kg)



ZIG + FLOATER HOOKLINK

- Designed specifically for floater fishing and Zig Rig fishing
- Made from a copolymer mono, which gives it an incredibly low diameter so it is very unobtrusive in the water
- Incredibly strong with great abrasion resistance
- Quite possibly the number one choice for most of Europe's best surface and Zig Rig anglers
- Available in 9lb, 12lb and 15lb



ILLUSION® TRANS KHAKI FLUOROCARBON LEADER

- Features our revolutionary Trans Khaki camouflage
- Perfect leader material for gin clear venues
- Doubles up as effective hooklink material
- The most invisible fluorocarbon Rob Hughes has ever dived over
- Sinks like a brick and is incredibly supple meaning it hugs the contours of the lakebed giving the ultimate in concealed presentation
- High abrasion resistance and low stretch
- Great knot strength
- Supplied on 50m spoils
- Available in 20lb (9kg) and 30lb (13.6kg)



ARMADILLO™

- Features colour break camouflage pattern
- Designed to be used as a braided snag/shock leader
- Great for distance casting or when fishing snaggy venues
- Available in Light Camo or Dark Camo
- New 65lb version available for extreme snag fishing conditions
- Available in either 30lb (13.6kg), 45lb (20.4kg) or 65lb (29.5kg) breaking strains
- 20m per spool



SUBMERGE™ LEAD FREE LEADER

- Great alternative to leadcore and perfect for venues that ban leadcore
- Incredibly supple, yet sinks like a brick and hugs the contours of the lakebed
- Great abrasion resistance
- Very easy to splice and splices are incredibly strong
- Available in Gravelly Brown and Weedy Green
- New 60lb version now available for extreme snag-fishing conditions
- Available in 30lb (13.6kg), 45lb (20.4kg) and 60lb (27.2kg) breaking strains
- Supplied on 10m spools



CAMO LEADCORE

- Great for concealment and abrasion resistance
- Easy to splice, very supple, very dense and very strong
- Features colour break camouflage pattern
- Available in two options in Light Camo and Dark Camo
- Available only in 45lb (20.4kg) breaking strain
- Supplied on both 7m and 25m spools

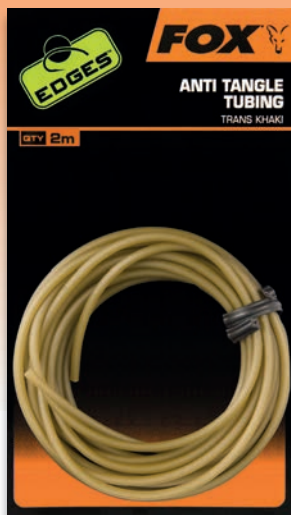

ANTI-TANGLE TUBING TRANS KHAKI

- Features revolutionary Trans Khaki camouflage
- Perfect for venues where leadcore is banned
- Added protection from abrasion and tangles
- Incredibly fish-friendly
- Supplied in 2m length

CAC564 Anti Tangle Tube 2m

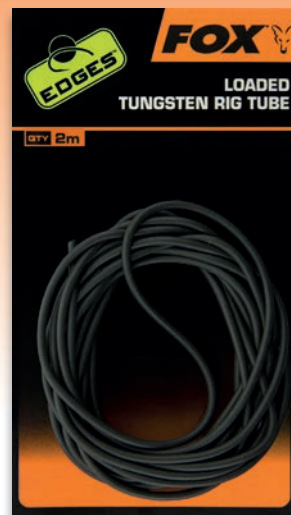

LOADED TUNGSTEN RIG TUBE

- Four times heavier than leadcore
- Very supple so hugs the lakebed very well
- Perfect for venues where leadcore is banned
- Very easy to thread onto your main line
- Supplied in 2m length

CAC535 Loaded Tungsten Rig Tube

NEW



FLUOROCARBON FUSED LEADERS

- Fused fluorocarbon with a plastic outer coating
- Offer abrasion resistance and also aid concealment
- 75cm long, 1 leader per packet
- Supplied with Edges Kwik Change Swivels in size 7 and 10
- 30lb breaking strain
- Non-glare, anti-spook finish

CAC694 Kwik Change Size 7

CAC695 Kwik Change Size 10



LEADER SILICONE

- Designed for use on Submerge and leadcore leaders for helicopter rigs
- 0.5mm in diameter
- Features Trans Khaki camouflage
- Supplied in 1.5m length

CAC569 0.5mm x1.5m

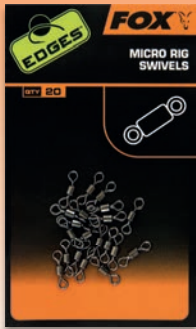

MICRO RIG SWIVELS

- Perfect for mounting hookbaits onto when using D-Rig presentations
- Ideal for Chod and Hinged Stiff Rigs
- 20 per packet

CAC538 Micro Rig Swivels x 20

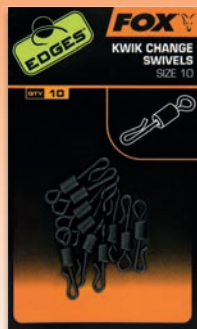

KWIK CHANGE SWIVELS

- Available in size 7 and 10
- Allows rigs to be changed without cutting and re-tying knots
- Anti-glare finish
- Perfect for use with Edges Safety and Slik lead clips
- 10 per packet

CAC485 Kwik Change Swivels Size 7 x 10

CAC486 Kwik Change Swivels Size 10 x 10



SWIVELS

- Perfect for a host of rig applications
- Anti-glare finish
- Available in two size – 7 and 10
- 20 swivels per packet
- Perfect for use with Edges Safety (size 7) and Slik (size 10) lead clips

CAC533 Swivels Size 7 x 20

CAC534 Swivels Size 10 x 20

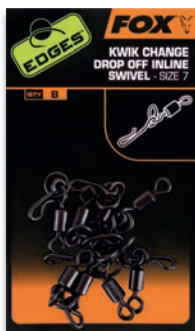

KWIK CHANGE DROP OFF INLINE SWIVEL

- Unique design for anglers who want to fish inline drop off but still have quick range facility with their rigs
- Size 7 swivel with anti glare finish
- 8 per packet

CAC494 Kwik Change Swivel Size 7



DOUBLE RING SWIVEL

- Perfect for anglers that fish inline drop off setup but want to tie rig straight to swivel
- Size 7 swivel with anti glare finish
- 8 per packet

CAC495 Double Ring Swivel Size 7 x 8



KWIK CHANGE 'O' RING

- Another design that is unique to the Edges range
- Designed for anglers that fish helicopter rigs but want to change hooklinks without cutting and tying knots
- Anti glare finish
- 10 per packet

CAC493 Kwik Change 'O' Ring x10



KURO MICROHOOK RING SWIVELS

- Perfect for mounting hookbaits onto when using D-Rig presentations
- Gives hookbaits greater flexibility and 360° movement
- Matt black Kuro coating
- Ideal for a host of rigs including 360, Chod, Hinged Stiff and Multi Rig
- 10 per packet

CAC586 Kuro Micro Hook Ring Swivel x 10

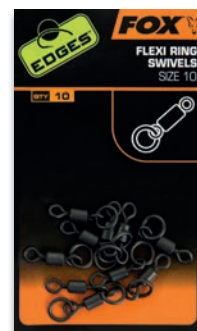

FLEXI RING SWIVELS

- Available in size 7, 10 and 11
- Anti-glare finish
- 10 per packet

CAC528 Flexi Ring Swivels Size 7

CAC609 Flexi Ring Swivels Size 10

CAC529 Flexi Ring Swivels Size 11

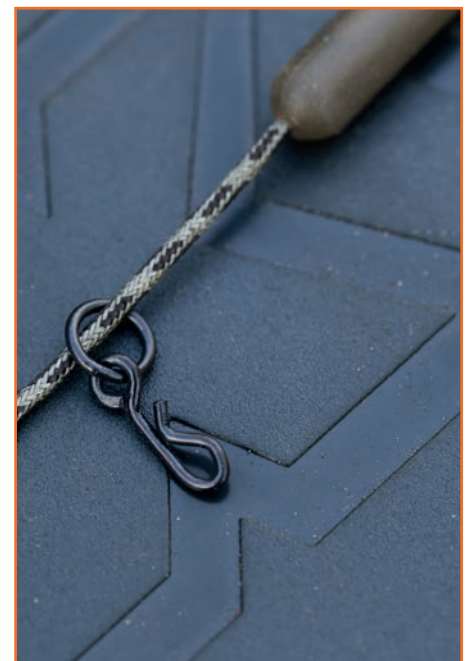

DROP OFF HELI BUFFER BEADS

- Versatile buffer bead that comprises three main components and is designed for helicopter-style lead setups
- Designed to work on both leaders and naked main line (simply add the tapered insert)
- Use without the tapered insert for lead-free/leadcore leaders
- Features Trans Khaki camouflage
- 6 x Buffer Beads and 6 x T-pegs per pack

CAC690 Drop Off Heli Buffer Beads



HELI/CHOD BUFFER SLEEVE

- Designed for Chod rigs and Helicopter rigs when fishing with fluorocarbon or mono main line straight through
- The swivel of your rig will sit on the thin, tapered sleeve, which will absorb the pressure when playing a carp and prevent the swivel damaging the line
- Small hole in the side allows you to set it up in a way that allows the lead to be ejected
- Trans Khaki colour
- 6 per packet

CAC490 Chod/Heli Buffer Sleeves x 6



HELI BUFFER SLEEVE

- Designed for use with Helicopter Rigs on leaders such as Submerge and leadcore
- Small hole in the side allows you to set it up in a way for the lead to be ejected
- Features Trans Khaki camouflage
- 8 per packet

CAC584 Heli Buffer Sleeves x8



TUNGSTEN CHOD BEAD KIT

- Designed to allow anglers to tie a 'fixed' Naked Chod Rig on fluoro or mono main line
- The bead itself grips the line very strongly but can be moved the distance above the lead you require
- The bottom sleeve, sits over the lead and can be setup in way to eject the lead on a take
- When you hook a fish the bead slides down the line and slots into the top of the sleeve to protect your line during the fight
- Micro version available for anglers that like to scale down their end tackle
- Supplied with 6 sleeves and 6 beads per kit

CAC488 Tungsten Chod Bead Kit x 6



MICRO CHOD BEAD

- Designed to allow anglers to tie a 'fixed' Naked Chod Rig on fluoro or mono main line
- The bead itself grips the line very strongly but can be moved the distance above the lead you require
- The bottom sleeve, sits over the lead and can be setup in way to eject the lead on a take
- When you hook a fish the bead slides down the line and slots into the top of the sleeve to protect your line during the fight
- Supplied with 6 sleeves and 6 beads per kit

CAC607 Micro Tungsten Chod Bead Kit x 6



BIG BORE DROP OFF INLINE LEAD KIT

- Designed with a larger bore for use with leadcore and larger diameter lead-free materials such as 60lb Edges Submerge
- Compatible with all Fox inline leads
- Allows inline lead to eject from line when fishing snaggy or weedy venues
- Comes supplied with a tail rubber if you want to increase the amount of pressure required to eject the lead
- 5 inserts and 5 tail rubbers per kit

CAC698 Big Bore Drop Off Inline Lead Kit



DROP OFF INLINE LEAD KIT

- Designed for use with all Fox inline leads
- Allows inline lead to eject from line when fishing snaggy or weedy venues
- Comes supplied with a tail rubber if you want to increase the amount of pressure required to eject the lead
- 5 inserts and 5 tail rubbers per kit

CAC487 Drop Off Inline Lead Kit x 5 Insert



DROP OFF LEAD PLUG & PINS

- Simply place the plug over your swivel and secure in place with T peg
- No longer need to cut inline lead insert in half when using Edges Drop Off Inline Lead Kit
- Means anglers can convert their drop off inline lead setup back to a standard inline lead setup should they wish to
- Designed to work with all Fox inline leads
- 10 plugs and 10 pins supplied per packet
- Feature Trans Khaki camouflage

CAC635 Drop Off Lead Plus & Pins



SAFETY LEAD CLIP TAIL RUBBER

- Trans Khaki Colour
- Designed for use with size 7 Safety Lead Clip
- Small cut away section allows easier ejection of lead
- 10 per packet



CAC478 Safety Lead Clip Tail Rubber

SAFETY LEAD CLIP

- Trans Khaki colour
- Designed for use with a size 7 swivel
- 'Self-aligning' swivel design, which means the eye of the swivel always sits in line with the hole in the lead clip
- Fixes to swivel with T-peg (supplied)
- Serrations on the lug allows for adjustable tension
- 10 per packet



CAC477 Safety Lead Clip & Pegs Size 7

SLIK® LEAD CLIP TAIL RUBBER

- Trans Khaki Colour
- Designed for use with size 10 Slik Lead Clip
- Small cut away section allows easier ejection of lead
- 10 per packet



CAC478 Safety Lead Clip Tail Rubber

SLIK® SAFETY LEAD CLIP

- Trans Khaki colour
- Smaller lead clip designed to work with size 10 swivels making them perfect for delicate presentations
- 'Self-aligning' swivel design, which means the eye of the swivel always sits in line with the hole in the lead clip
- Fixes to swivel with T-peg (supplied)
- No serrations on the lug ensures that the tail rubber slips off easily
- Perfect for weedy and snaggy venues where ejecting the lead on a take is vital
- 10 per packet



CAC479 Slik® Lead Clips & Pegs Size 10

POWER GRIP LEAD CLIP KIT

- Handy kit that includes everything needed for creating a lead clip setup
- Includes following Edges Trans Khaki products: Power Grip Tail Rubbers, size 7 Lead Clips with T pegs, standard Anti Tangle Sleeves
- Also supplied with both standard size 7 swivels and size 7 Kwik Change Swivels.
- Five of every component supplied in kit



CAC638 Power Grip Lead Clip Kit

POWER GRIP NAKED LINE TAIL RUBBER

- Tougher grip on lead clip for use with heavier leads
- Fine taper at rear of tail rubber for use with fluorocarbon leaders or fishing main line straight through
- Helps to prevent hooklinks from tangling around the tail rubber
- Ideal for long rigs such as Zig Rigs
- Trans Khaki camouflage
- Designed for use with size 7 lead clips
- 10 per packet



CAC686 Power Grip Naked Line Tail Rubbers

NAKED LINE TAIL RUBBERS

- Fine taper at rear of tail rubber for use with fluorocarbon leaders or fishing 'naked' main line straight through
- Helps to prevent hooklinks from tangling around the tail rubber
- Ideal for long rigs such as Zig Rigs
- Front of tail rubber features cut away section to aid lead ejection
- Trans Khaki camouflage
- 10 per packet



CAC636 Naked Line Tail Rubbers

POWER GRIP TAIL RUBBERS

- Designed for anglers that like to use heavy leads ensuring lead doesn't eject on impact with water after a cast but still ejects when comes into contact with snag/weed
- Designed to work with a size 7 Edges Lead Clip
- Trans Khaki camouflage
- 10 per packet



CAC637 Power Grip Tail Rubbers

TADPOLE MULTI BEAD

- Trans Khaki colour
- Perfect for creating semi-fixed running setup with inline leads
- 10 per packet



CAC476 Tadpole Multi Bead

RUN RING KIT

- Simple design to create a basic running rig
- Large ring for friction free movement
- Allows great bite indication
- Features 8 x Rings, 8 x Buffer Beads and 8 x Speed Links
- Features Trans Khaki camouflage



CAC583 Running Ring Kit

RUNNING SAFETY CLIP

- Features Trans Khaki camouflage
- Designed to allow you to create the perfect running rig presentation
- T-bar peg to lock the swivel in place inside main clip
- The clip is sculpted to allow the lead to hang straight for increased casting distance
- Tail rubber is designed to be used with both leadcore style leaders and tubing
- Kit includes a Run Ring and Speed Link so you can attach your lead of choice
- Pack size: 6



CAC582 Running Safety Clips

TULIP BEADS

- Perfect for use with running rigs
- Angled to allow lead to sit at optimum angle for tangle-free casts
- Can also be used as a buffer bead on marker float set up
- Trans Khaki camouflage



CAC599 Tulip Beads

ANGLED DROP OFF RUN RIG KIT

- Unique design that takes running rigs to another level
- Angled, large ring sits in perfect place to allow line to run through unhindered
- Can be set up to eject the lead when fishing weedy or snaggy venues
- Trans Khaki Camouflage
- Comprises 6 x Angled Clips, 6 x Angled Buffer Sleeves and 6 x T-Pegs



CAC600 Angled Drop Off Run Rig Kit x 6

TRANS KHAKI ANTI TANGLE SLEEVES

- Trans Khaki colour
- Designed to help prevent rigs from tangling on cast
- Standard ideal for normal every day rig presentations
- Micro sleeve available for solid PVA bag fishing
- XL sleeve ideal for use with long hooklinks such as Zig Rigs
- 25 per packet (Micro and standard); 15 per packet (XL)



CAC481 Anti Tangle Sleeves x 25

CAC555 Anti Tangle Sleeves Micro x 25

CAC554 Anti Tangle Sleeves X Large x 15

TUNGSTEN ANTI TANGLE

- Designed to help prevent tangles occurring on the cast
- Added weight of tungsten helps to keep your hooklink pinned to the lakebed
- Available in standard and Micro sizes
- 8 sleeves per packet



CAC630 Tungsten Anti Tangle Sleeve Micro

CAC631 Tungsten Anti Tangle Sleeve Standard

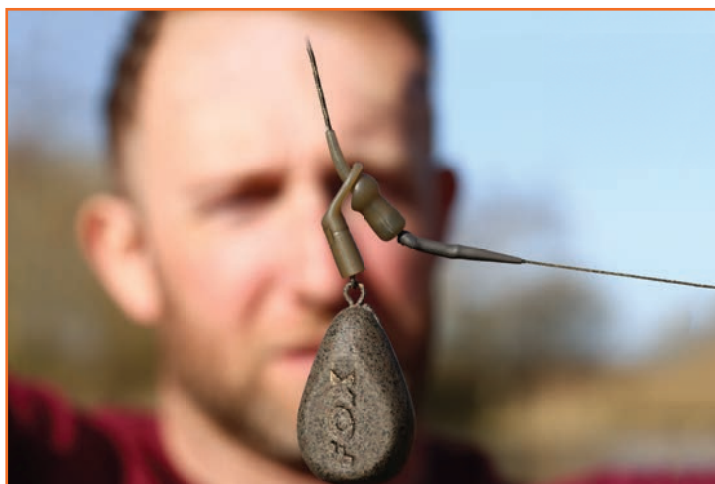

TUNGSTEN LINE GUARD BEADS

- Designed for use directly onto naked main line
- Can be fixed up the line for use with Naked Chod Rigs (will slide down and sit on top of Heli Buffer Sleeve once a fish is hooked)
- Can also be positioned directly on top of a Heli Buffer Sleeve when fishing naked helicopter-style rigs
- Handy tapered side that your hooklink swivel sits on during the fight to keep main line protected
- Tungsten content helps to sink them to lakebed
- Supplied on wire loop for easy loading to main line
- 8 beads per packet

CAC671 Tungsten Line Guard Bead x8



TAPERED MAINLINE STOP

- Large tapered stop for use on main line, which you can then place a 5mm Tungsten Bead onto when fishing Chod or Helicopter rigs 'naked' style
- Taper allows hooklink swivel to dislodge bead easier making it safer than conventional designs
- Supplied on wire loop, 9 per packet

CAC492 Tapered Mainline Stoppers x 9



TUNGSTEN HOOKLINK SINKERS

- Designed to mimic look for tungsten putty on hooklink
- Ideal for helping to pin your hooklink to lakebed
- Supplied on wire loop, 9 per packet

CAC585 Tungsten Hooklink Sinkers



5MM TUNGSTEN BEAD

- 5mm bead made from tungsten
- Designed to fit neatly onto the Tapered Mainline Stop
- 15 beads per packet

CAC489 Tungsten Bead 5mm x 15



TUNGSTEN POWERGRIP® PUTTY

- Extremely dense
- Very easy to work with
- Perfect for counterbalancing pop-ups and pinning rigs to lakebed
- Widely regarded as best on the market

CAC541 Powergrip Putty



BAIT BUNGS

- Designed to prevent a hookbait sliding down the Hair towards the hook
- Especially useful when using snowman presentation to keep two baits next to each other on the Hair
- Simply slide onto the hooklink before tying the loop on the Hair
- Supplied on wire loops
- 10 Bungs per packet

CAC687 Bait Bungs



TAPERED BORE BEADS

- Available in 6mm and 4mm
- Feature Trans Khaki camouflage
- 4mm designed to grip leadcore when using Helicopter and Chod rigs
- 6mm beads perfect for acting as a buffer to protect knots
- 6mm beads can also be placed on silicone on a leader when using Chod and Helicopter rigs
- 30 beads per packet

CAC557 4mm Bore Beads x 30

CAC558 6mm Bore Beads x 30

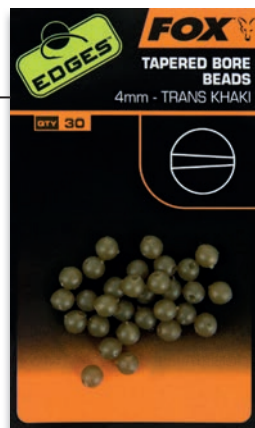

ANTI BORE BAIT INSERTS

- Unique design that is pushed into base of hookbait to prevent Hair erosion
- Ideal for boilies and soft hookbaits such as meat
- Comes into its own when repeatedly casting out and reeling in
- Micro serrations on tube ensure rock solid fit
- Can be cut down to fit smaller baits



CAC539 Anti Bore Bait Insert

SILICONE SLEEVES

- 3mm bore in 25mm lengths
- Features Trans Khaki camouflage
- Perfect for numerous rig applications such as placing over Speed Links
- 15 lengths per packet



CAC571 Silicone Sleeves

HOOK SILICONE

- Designed for trapping Hair on shank of hook for blow back rigs
- Features Trans Khaki Camouflage
- Supplied in 1.5m lengths
- Two sizes available for different hook sizes – 10-7 and 6-2

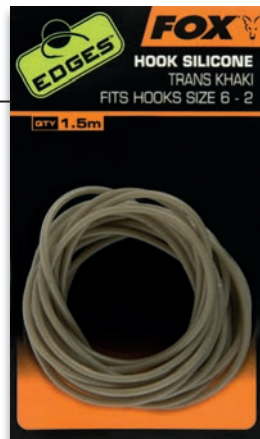

CAC567 Hook Silicone 10 - 7

CAC568 Hook Silicone 6 - 2

SHRINK TUBE

- Perfect for extending shank of hook when making anti-eject rigs
- Trans Khaki colour
- Available in three sizes: X Small (1.4-0.6mm), Small (1.8-0.7mm) and Medium (2.4-0.8mm)



CAC474 X Small - 1.4 - 0.6

CAC475 Small - 1.8 - 0.7

CAC570 Medium - 2.4 - 0.8

WITHY CURVES

- Pre-curved adaptor set at perfect angle for Withy Pool Rig
- Threads onto hooklink via splicing needle
- Features Trans Khaki camouflage
- Micro serrations on the end of the sleeve for tungsten putty to mould around to counter balance your pop-up hookbait
- No longer need to shrink tubing down over a kettle to create this all-time classic rig!
- Two sizes available for different hook sizes – 10-7 and 6-2
- 10 per packet



CAC561 Hook Size 10-7

CAC562 Hook Size 6-2

LINE ALIGNA

- Makes creating a line aligner presentation easier than ever before
- Features Trans Khaki camouflage
- Simply slide an Aligna down your hooklink and over the eye of your hook
- Creates an aggressive hooking angle that carp find very hard to eject
- Two sizes available for different hook sizes – 10-7 and 6-2
- 10 per packet



CAC560 Hook Size 6-2

CAC559 Hook Size 10-7

MICRO LINE ALIGNAS

- More refined version of the hugely popular Trans Khaki Line Alignas
- Ideal for anglers that wish to fish scaled-down, delicate presentations
- Eliminates need for shrink tube
- Helps to create perfect aggressive hooking angle
- Available in two sizes – 10-7 and 6-2
- 10 per packet



CAC633 Micro Line Aligna 10-7

CAC634 Micro Line Aligna 6-2

HAIR WIDGETS

- Design to tightly grip shank of hook
- Enables Hair rig to be created without tying knotless knot
- Simply tie a supple hair to the Hair Widget and position it in chosen place on hook
- Features Trans Khaki camouflage
- 30 per packet

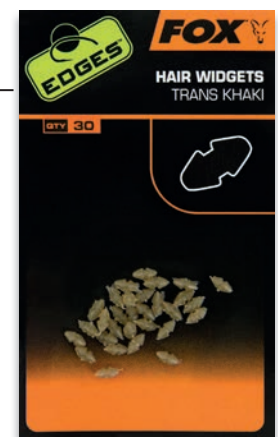

CAC556 Hair Widgets x 30

HOOK BEADS

- Trans Khaki Colour, 25 beads per packet
- Ideal for blowback presentation where a knotless knot isn't used
- Grip the shank of the hook very tightly
- Available in two sizes: 7-10 and 2-6

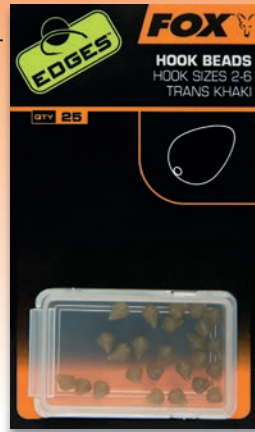

CAC482 Hook Bead - Size 7-10

CAC483 Hook Bead - Size 2-6

HEAVY DUTY 'O' RING

- Designed for use when setting up helicopter and Chod rigs to eject the lead on the take
- Anti glare finish
- 15 per packet

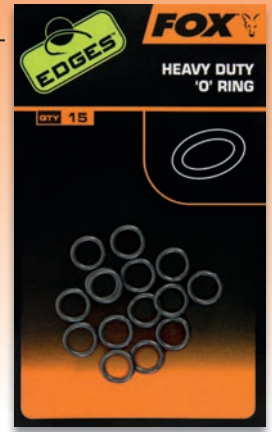

CAC496 Heavy Duty 'O' Ring x 15

KURO RIG RINGS

- Perfect for a host of rig applications including creating Blowback Rigs
- Feature matt black Kuro coating
- Available in three sizes – Small (2.5mm), Medium (3.2mm) and Large (3.7mm)
- 25 rings per packet

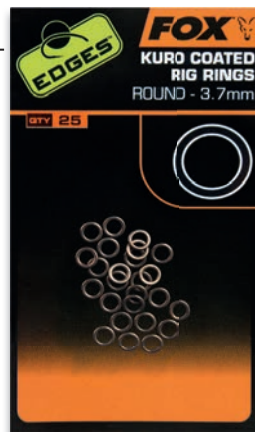

CAC543 Kuro Rig Rings 2.5mm

CAC544 Kuro Rig Rings 3.2mm

CAC545 Kuro Rig Rings 3.7mm

SPEED LINKS

- Designed to allow quick changing of rigs
- Can also be used for quick changing of items such as marker floats and spods
- Available in two sizes – standard and Micro
- 20 Speed Links per packet

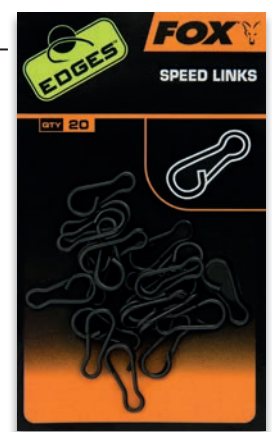

CAC532 Speed Links x 20

MICRO SPEED LINKS

- Scaled down version of original Speed Link
- Designed to allow quick changing of rigs
- Can also be used for quick changing of items such as marker floats and spods
- 20 per packet

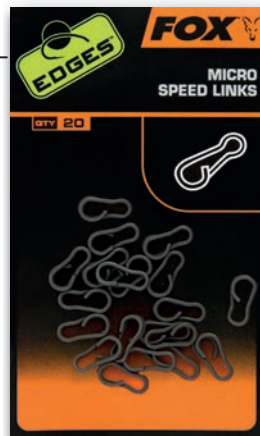

CAC566 Micro Speed Links

RIG LINKS

- Designed to replace loop knots on end of rig
- Simply tie Rig Link to end of rig with a Grinner Knot
- Allows rigs to be changed in double-quick time
- Enables PVA sticks to be threaded down hooklink
- 15 per packet



CAC542 Rig Links x 15

MAGGOT CLIPS

- Designed for easy presentation of maggots on Hair Rigs
- Unique arrowhead shape to prevent maggots bunching up
- Feature chemically sharpened points with non-rust finish
- Available in four sizes – 6, 8, 10 and 12
- 10 clips per packet



CAC524 Maggot Clips Size 6

CAC525 Maggot Clips Size 8

CAC526 Maggot Clips Size 10

CAC527 Maggot Clips Size 12

HAIR BRAID

- Designed to allow anglers to create super-supple Hair rigs
- Discreet brown colour
- Perfect when using small, lightweight hookbaits
- Supplied in 10m lengths



CAC565 Hair Braid 10m

KWIK CHANGE POP-UP WEIGHTS

- Pop-up counter weight system
- Easy to attach to hooklinks without causing any damage
- Weights simply attach to small silicone length that is supplied on dispensers
- Available as individual weights – BB, AAA, SA and Swan
- Six division dispenser also available featuring No.1, No.4, BB, AAA, SA and Swan

CAC513	Pop-Up Weights BB
CAC514	Pop-Up Weights AAA
CAC515	Pop-Up Weights SA
CAC516	Pop-Up Weights Swan
CAC518	Weights Dispenser



MULTI PURPOSE BACKLEAD

- Can be used as a quick-change flying backlead or converted into a traditional 'clip on' backlead.
- To change, simply remove the quick-change flying insert from the lead and replace with the 'clip-on' backlead insert by pushing it into the core, twist the insert once in place to ensure lead cannot come off
- If the 'clip-on' backlead should become snagged, it is designed to release from the line as the clip will spring open, releasing your line
- When used in flying backlead mode it has been designed not to fly too far back up the line like other makes currently do, this helps to ensure that the line closest to your rig will be pinned down
- Perfect for pinning your line to the lakebed when fishing for line-shy carp, also ideal when fishing on venues with boat traffic to keep the line out of harm's way
- Available in 3 sizes – 5g, 10g and 15g
- Each pack contains 4 x leads, 4 x flying backlead inserts and 4 x 'clip-on' backlead inserts



CAC653	Multi Purpose Backlead 5g
CAC654	Multi Purpose Backlead 10g
CAC655	Multi Purpose Backlead 15g

CAPTIVE BACK LEADS MK2

- Perfect for angler who wish to keep their line concealed
- Patented line clip allows for smooth line release
- Heavier options allow you to fish with tighter lines for better indication
- Supplied on own winder
- Comes supplied with 10m highly visual orange cord
- Cord freely dispenses from winder



CBW001	Captive Back Leads MK2 1.25oz / 35g
CBW002	Captive Back Leads MK2 2oz / 56g
CBW003	Captive Back Leads MK2 3oz / 85g
CBW004	Captive Back Leads MK2 4oz / 113g
CBW005	Captive Back Leads MK2 5oz / 142g

SLIDERS

- Tapered flying back leads for rig-shy carp
- Features camouflage pattern
- Simply thread onto main line above leader
- 10 Sliders per packet



CAC537	Sliders x 10
--------	--------------

DOWN RIGGER BACKLEADS

- Unique backlead system that can be attached to main line with one hand
- Available in two sizes – 21g and 43g
- Three backleads per packet



CAC312	Down Rigger Back Leads 21g x 3 Brown
CAC313	Down Rigger Back Leads 43g x 3 Brown

BAIT FLOSS

- Designed for attaching hookbaits to rig rings and Mini Hook Ring Swivels
- Neutral colour
- Supplied in dispenser with built-in cutter
- 50m per spool



CAC512 Bait Floss 50m

BOILIE STOPS

- Feature tapered ends for easy placing into Hair loop
- Small and discreet on top of boilie
- Clear colour
- Available in two size – Micro and Standard
- 200 boilie stops per packet

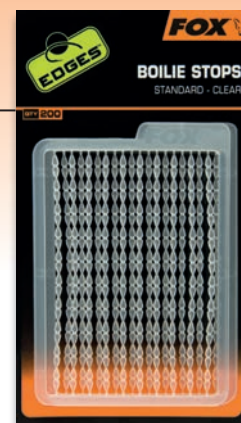

CAC592 Boilie Stops Micro

CAC593 Boilie Stops Standard

HAIR EXTENDING BOILIE PROPS

- Allows you to change the size of your hookbait without tying a new Hair Rig
- 3 sizes per packet – small, medium and large
- Clear colour



CAC497 Extending Boilie Prop

BOILIE CAPS

- Mini hook on base that pulls up into hookbait
- Makes it very hard for nuisance species to dislodge bait from Hair
- Small, clear cap almost disappears on top of bait
- 120 Boilie Caps per packet



CAC601 Boilie Caps

PELLET PEGS

- Designed for securing pellets in place on Hair Rigs
- Low-vis clear colour
- Available in three sizes – 11mm (180 pegs), 13mm (134 pegs) and 21mm (50 pegs)



CAC519 11mm Pellet Pegs x 180

CAC520 13mm Pellet Pegs x 134

CAC521 21mm Pellet Pegs x 50

MARKER ELASTIC

- Red elastic supplied on a 20m spool
- Perfect for marking fishing lines to ensure accurate casting and bait placement
- Very easy to work with, grips the line without damaging it
- Easy to remove from line again without damaging it



CAC484 Marker Elastic 20m Red



FINE NEEDLE

- Perfect for delicate hookbaits such as particles
- Also suited to soft, small 6-10mm boilies
- Soft-touch easy grip, green handle

GATED NEEDLE

- Gate latch baiting needle for use with variety of hookbaits
- Also helpful for threading small PVA bags onto hooklink
- Soft-touch easy grip, yellow handle

EASY SPICE NEEDLE

- Twisted stainless steel wire designed for splicing leadcore and lead-free leader materials as well as splicing Edges Camo-Splice hooklink material
- Diamond shaped for ease of use

SPICING NEEDLE

- Fine gate latch needle for splicing leadcore and lead-free materials
- Can also be used as a baiting needle for small, soft, delicate hookbaits
- Soft-touch easy grip, blue handle

HEAVY NEEDLE

- Perfect for tougher hookbaits such as boilies and nuts
- Soft-touch easy grip, red handle

CAC588	Fine Needle
CAC522	Splicing Needle
CAC590	Gated Needle
CAC589	Heavy Needle
CAC699	Easy Splice Needle NEW

STIX & STRINGER NEEDLE



- Extra long gate latch needle
- Ideal for creating PVA stringers
- Also suited to threading PVA sticks onto hooklinks

CAC523 Stix & Stringer Needle

NEEDLE SET



- Five-piece needle set that features everything you need
- Comprises Stix & Stringer, Fine, Heavy, Gated and Splicing needles

CAC598 Needle Set



MULTI TOOL

- Handy device that features four tools in one!
- One end is a line stripper for removing outer coating from coated braids
- Tension hook on opposite end to stripper, which is used for tightening knots and straightening stiff materials
- Also features small D-Rig spike for opening out and creating a neat D shape

CAC587 Multi Tool

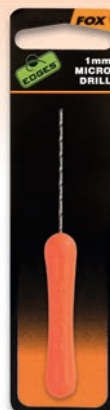

1MM MICRO DRILL

- Designed for drilling ultra fine holes into hookbaits
- Allows you create a bore in a hard bait for your baiting needle
- Perfect for hard baits such as nuts, air-dried boilies and corkball pop-ups
- Ergonomically designed highly visual handle

CAC632 1mm Micro Drill



BRAID BLADES

- Super-sharp blades for effortless cutting of braided materials
- Also great for cutting materials like fluorocarbon, nylon and leader materials
- Hi-vis orange handle to prevent you losing them in the grass etc

CAC563 Braid Blades

BRAID BLADES XS

- Saw-toothed blades designed to cut easily through all manner of materials including braid, nylon, stiff mono, fluorocarbon, leadcore and coated braid
- Razor-sharp
- Handy locking clip to keep them closed when not in use
- Fit neatly into your F Box tackle box

CAC563 Braid Blades

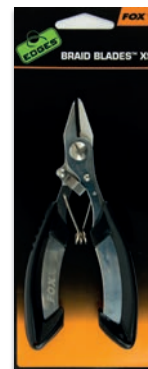

TENSION BAR

- Handy tool for tightening loops
- Also useful when straightening out boom sections on stiff rigs
- Ergonomic grip

CAC510 Tension Bar



BAIT DRILL & CORK STICKS

- Small drill that is used to bore out hookbaits
- Ideal for baits such as boilies and tiger nuts
- Ergonomic handle on drill for easy use
- Supplied with 5 cork sticks (6mm) for inserting into baits to give them increased buoyancy
- 6mm Cork Sticks also available to purchase separately

CAC591 1.5mm Nut/Pellet Drill



CAMOTEX® LEADS

FLAT PEAR SWIVEL



- Low profile
- Large eye swivel
- Camouflage, anti-glare finish
- Perfect for short/medium range

INLINE FLAT PEAR



- Features groove on outside for use with inline drop off rigs
- Low profile
- Solid plastic insert
- Camouflage, anti-glare finish
- Perfect for short-medium range or long range when fished inside solid PVA bag
- Inline leads feature hard, plastic inserts for use with size 7 swivels

IMPACT INLINE



- Rig exits the lead from the centre to ensure the fish comes into contact with the full weight of the lead upon straightening the hooklink
- Unique design helps to set the hook and convert more pick ups
- Perfect for short-medium range plus solid PVA bag fishing
- Features Camotex camouflage coating
- Available in three sizes – 3oz/85g, 4oz/113g and 5oz/142g
- Can also be fished inline drop off style in conjunction with Edges Drop Off Inline Kit

SQUARE SWIVEL



- Perfect for fishing on slopes
- Offer great resistance when fish picks up rig
- Large eye swivel
- Camouflage, anti-glare finish
- Perfect for short-medium range

SQUARE INLINE



- Features groove on outside for use with inline drop off rigs
- Offers great resistance when fish picks up rig
- Solid plastic insert
- Camouflage, anti-glare finish
- Perfect for short-medium range or long range when fished inside solid PVA bag

DISTANCE SWIVEL



- Perfect for casting long distances
- Aerodynamic profile
- Large eye swivel
- Camouflage, anti-glare finish



Weight imprinted on the lead itself



All swivels also feature camouflage coating



Hardwearing, anti-glare camouflage coating



Inline leads feature hard, plastic inserts for use with size 7 swivels

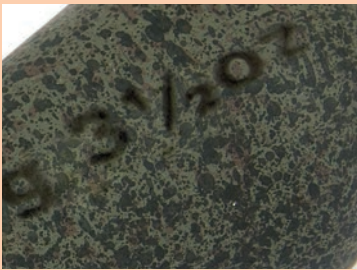

Weight imprinted on the lead itself



All swivel leads feature rubber coated swivels with large eyes



Rubberised coating gives non-reflective and durable camouflage coating



Inline leads feature soft rubber inserts that fit on size 7 swivels

CARP LEADS

FLAT PEAR

- Dumpy condensed shape
- Perfect for slopes and sides of bars
- Shapes offers great bolt effect
- Swivel and inline
- Brown and Green



TRI-BOMB

- Perfect all-rounder
- Weight forward design increases resistance
- Stable in flight
- Swivel and inline
- Brown and Green



PASTE BOMB

- Perfect for use with paste or Method mixes
- Increases attraction around hookbait
- Better hooking potential than traditional feeder
- Swivel and inline
- Brown and Green



KLING ON

- Unique to Fox
- Flat profile and pronounced studs give unrivalled grip on slopes
- Perfect for running water and long range boat fishing
- Swivel and inline
- Brown and Green



EXOCET®

- Weight forward design for long range casting
- Very stable in flight
- Distances in excess of 200m achieved
- Swivel
- Brown and Green



ELEVATOR™

- Unique shape ideal for flowing water
- Three sided profile enable lead to lift off lakebed instantly and hit surface much quicker
- Swivel
- Brown and Green



HORIZON®

- Hexagonal shape makes lead perfect for distance casting
- Very stable in flight
- Flat sides help lead to hold bottom
- Swivel and inline
- Brown and Green



MICRO MARKER FLOATS

- Perfect for feature finding and depth reading
- Ideal for short-medium range with leads up to 3oz (85g)
- Each pack contains three colours – yellow, black and orange
- Full kit option also available



CAC381	Micro Marker x3
CAC382	Micro Marker Float Kit x3



EXOCET® & DART MARKER FLOATS

- Perfect for feature finding and depth reading
- Constructed from high impact materials to make them robust and reliable
- Both available as float alone or as part of a kit, which includes 3 x flights, large eye ring swivel, anti-tangle boom and buoyancy aid
- Air cavity for extra buoyancy

CAC353	Exocet Marker Float
CAC354	Exocet Marker Float Kit 3oz
CAC355	Exocet Marker Float Kit 4oz
CAC368	Dart Marker Float
CAC369	Dart Marker Float Kit 2oz
CAC370	Dart Marker Float Kit 3oz

GRAPPLING MARKER LEADS

- Unique design to aid your feature finding
- Features four prongs that will pick up traces of lakebed debris, weed and natural food items to enable you to establish exactly what you are fishing over
- Weight forward design enables them to be cast a long way
- Dumpy nose ensures more of the lead is in contact with the lakebed so more vibrations are transmitted up the braided line to the marker rod tip
- Once you have identified a likely-looking spot with a normal lead simply swap to this design for a more thorough investigation
- Two leads per pack
- Available in three sizes – 3oz/85g, 4oz/113g and 5oz/142g



CLD229	Grappling Marker Lead 3oz (85g) x 2
CLD230	Grappling Marker Lead 4oz (113g) x 2
CLD231	Grappling Marker Lead 5oz (142g) x 2

CASTING FINGER STALL

- Unique ambidextrous design so will work for both left and right-handed casters
- Soft protective material on finger that is more sensitive than traditional leather finger stalls enabling better 'feel' when casting
- Quick-drying material



CAC572	Casting Finger Stall
--------	----------------------



H-MARKER

- Designed for marking spots when boat fishing
- Bright orange for maximum visibility
- Ultra buoyant
- Betalight slots
- Supplied with heavy lead weight to anchor to the lake/river bed
- Supplied with 20m (65ft) cord

CAC424	H-block Marker
--------	----------------



MINI H-BLOCK MARKER

- Handy mini version of our H-Marker for anglers that wish to angle with a little more stealth or use a bait boat
- Bright orange for maximum visibility
- Ultra buoyant
- Betalight slots
- Supplied with Swivel & Speed Link for easy lead attachment
- Supplied with 10m (32ft) cord
- Two per packet

CAC426	Mini H-blocks x 2 red
--------	-----------------------

ZIG ALIGNA™ BENEFITS

- Better hookholds and anti-eject properties - Creates a much wider gape than a standard knotless knot or Zig Bug style hook (no fluff or foam impeding hook point penetration), for much better hooking potential
- Better hooking potential - The Aligna allows your hookbait to sit centralised at all times, a downside with a knotless knot on light mono is that the Hair naturally wants to sit off to one side, which can lead to poor hook holds
- Stronger more reliable knots can be used - Allows you to attach your hook to your hooklink with a Palomar or Grinner Knot rather than a Knotless Knot, which are much stronger and also prevents the eye of your hook from rubbing on and weakening the hooklink when playing a fish
- Far greater value for money - Should your hookpoint turn over you can simply slide the Aligna up your hooklink and attach a new hook – with Zig Bug style hookbaits once the point has gone they have to be thrown away, which can get very expensive
- Very versatile – You can mix and match the colours of foam and Zig Aligna to create a whole host of hookbait colour options until you find the combo that works the best on any given day
- Very quick and easy – Changing of your hookbait is very quick to do and swapping hookbaits is also very fast thanks to the unique loading tool
- Imitate shape of emerging larvae – Most Zig Bug style hookbaits imitate creatures that live out of the water, which is a pretty pointless imitation as they are not natural! The shape of the Zig Aligna combined with a foam insert very much replicates the shape of a nymph with a thin curved body and a big head
- Hi-Vis colour options – The red, pink, white and yellow options allow you to create hi-viz hookbaits when single hookbait fishing or spodding a slop over the top

ZIG ALIGNA™ KIT

- 3 lengths of Zig Aligna HD Foam
- 6 Zig Aligna Sleeves
- 1 x Loading Tool

CAC467	Zig Aligna Kit (Black, Red, Yellow)
CAC508	Zig Aligna Kit (Pink, White, Brown)
CAC664	Zig Aligna Kit (Pink, Yellow, Orange)



ZIG ALIGNA™ LOADING TOOLS

- Designed for loading foam into loop on back of Zig Aligna
- Hi-vis orange colour
- Two per packet



CAC506 Zig Aligna Loaded Tools x 2 Orange



ZIG ALIGNA™ HD FOAM

- Available in Red, Yellow, Black, Fluoro Pink, Fluoro Yellow and Fluoro Orange
- 3 lengths of foam per packet
- Ultra buoyant

CAC471	Zig Aligna Foam x 3 Red
CAC472	Zig Aligna Foam x 3 Yellow
CAC473	Zig Aligna Foam x 3 Black
CAC668	Zig Aligna Foam Fluoro x 3 Orange
CAC669	Zig Aligna Foam Fluoro x 3 Yellow
CAC670	Zig Aligna Foam Fluoro x 3 Pink

ZIG ALIGNA™ SLEEVES

- Available in Red, Yellow, Black, Brown, Pink, Fluoro Pink, Fluoro Yellow and Fluoro Orange
- 8 Zig Aligna Sleeves per packet

CAC468	Zig Aligna Sleeves x 8 Red
CAC469	Zig Aligna Sleeves x 8 Yellow
CAC470	Zig Aligna Sleeves x 8 black
CAC546	Zig Aligna Sleeves x 8 Brown
CAC547	Zig Aligna Sleeves x 8 Pink
CAC665	Zig Aligna Sleeves Fluoro x 8 Orange
CAC666	Zig Aligna Sleeves Fluoro x 8 Yellow
CAC667	Zig Aligna Sleeves Fluoro x 8 Pink

IMPACT SPOD

Having looked at the bait delivery devices currently available on the market our product design team at Fox believed that there was still room for further development for a product that could perform in a different way. Following an extensive three year research and development programme plus countless hours of field testing the Fox Impact Spod was born.

Sold under licence from Spomb® Fishing Limited, the Impact Spod boasts a number of unique features that sets it apart from any other bait delivery device currently on the market. Features such as a unique 'scoop' body shape, allow for rapid, single handed loading. This unique body and lid design not only enables you to fill the device very quickly, it also allows for highly efficient loading, resulting in a 'one scoop' operation that fills the entire inner compartment! This 'complete fill' enables you to put your bait out as quickly as possible, and additionally allows for an even weight distribution, which in turn makes it very stable in flight. Another benefit of the scoop design, in addition to the easy loading, is that it enables a tapered bait release should you wish to create a wider spread of free offerings, as opposed to tightly grouped patches, this feature can be particularly handy when fishing a boilie-only approach or 'big hit' fishing with multiple rods on one large baited area.

		*RRP
CAC639	Impact Spod Medium	£11.99
CAC640	Impact Spod Large	£13.99



Robust hinge that cannot be impeded by bait



Spring mechanism on nose is encapsulated to prevent bait interference



Large heavy-duty swivel moulded into flight

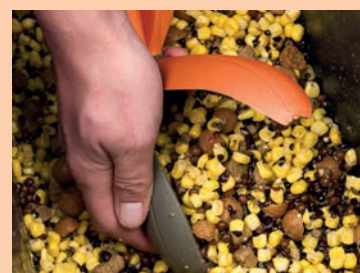

The Impact Spod is sold under licence from Spomb Fishing Limited. SPOMB® is a Registered Trade Mark of Spomb Fishing Limited

MARKER STICKS

- 24ins (60cm) long sticks for measuring distance to enable accurate casting
- Hi-vis, tapered orange tops with betalight slot in top
- Lightweight aluminium construction
- Two sticks supplied per pack



		*RRP
CAC616	Marker Sticks 24" x 2	£9.99

RANGEMASTER® POWERGRIP METHOD POUCH

- Curved ergonomic handle for increased comfort and control – curve in handle corrects for, and prevents the need for, wrist flexion when baiting
- Moulded Method pouch prevents groundbait ball from being crushed when under tension
- Textured rubber grip on pouch
- One piece monocoque polymer frame
- 'Teardrop' profile on handle to prevent twisting in the hand when in use, which aids accuracy
- Sculptured finger grips for greater comfort and control
- Wide elastic connections for improved elastic flow through frame with reduced tangling
- Non-tear material on pouch



		*RRP
CPT025	Method Pouch Catapult	£13.99

RANGEMASTER® POWERGRIP MULTI POUCH

- Curved ergonomic handle for increased comfort and control – curve in handle corrects for, and prevents the need for, wrist flexion when baiting
- One piece monocoque polymer frame
- 'Teardrop' profile on handle to prevent twisting in the hand when in use, which aids accuracy
- Sculptured finger grips for greater comfort and control
- Wide elastic connections for improved elastic flow through frame with reduced tangling
- Deep conical pouch, for optimum baiting loads and accuracy
- Non-tear material on pouch
- Pouch has non-slip grip for easier use with wet and cold hands
- Multi-purpose pouch that is ideal for a wide variety of baits including boilies, particles and pellets

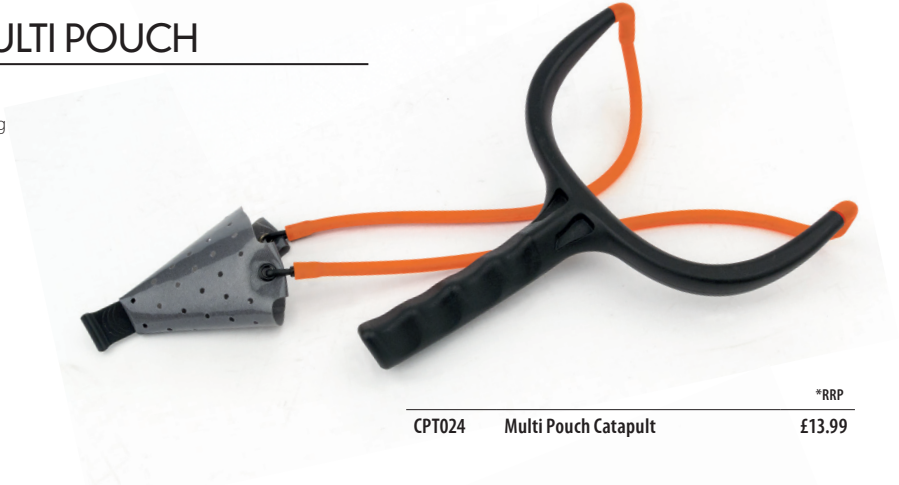

		*RRP
CPT024	Multi Pouch Catapult	£13.99

RANGEMASTER® POWERGUARD® METHOD POUCH

- Curved ergonomic handle for increased comfort and control – curve in handle corrects for, and prevents the need for, wrist flexion when baiting
- Features patented knuckle defender
- Swing Head fixings help to prevent elastic from twisting
- Moulded Method pouch prevents groundbait ball from being crushed when under tension
- Textured rubber grip on pouch
- One piece monocoque polymer frame
- 'Teardrop' profile on handle to prevent twisting in the hand when in use, which aids accuracy
- Sculptured finger grips for greater comfort and control
- Non-tear material on pouch
- Spare elastics, pouches and elastic connectors available separately



		*RRP
CPT027	Method Pouch Catapult	£15.99
CPT028	Spare Elastic & 2x Connectors	£5.49
CPT030	Spare Method Pouch & 2x Connectors	£7.49

RANGEMASTER® POWERGUARD® MULTI POUCH

- Curved ergonomic handle for increased comfort and control – curve in handle corrects for, and prevents the need for, wrist flexion when baiting
- Features patented knuckle defender
- Swing Head fixings help to prevent elastic from twisting
- Textured rubber grip on pouch
- One piece monocoque polymer frame
- 'Teardrop' profile on handle to prevent twisting in the hand when in use, which aids accuracy
- Deep conical pouch, for optimum baiting loads and accuracy
- Non-tear material on pouch
- Pouch has non-slip grip for easier use with wet hands
- Multi-purpose pouch that is ideal for a wide variety of baits including boilies, particles and pellets
- Spare pouches and elastic connectors available separately



		*RRP
CPT026	Multi Pouch Catapult	£15.99
CPT028	Spare Elastic & 2x Connectors	£5.49
CPT029	Spare Multi Pouch & 2x Connectors	£7.49



RANGEMASTER® R20 CARBON THROWING STICK

- Lightweight carbon construction
- Handy loading port above handle for effortless loading and faster more accurate baiting
- Reduces arm-ache associated with metal and plastic sticks when mass baiting
- Handle is oval shaped to prevent twisting in the hand, which in turn aids accuracy
- Distances over 150m achieved in right hands
- For use with baits up to 20mm
- Supplied in protective case



Rangemaster® R20 Carbon Throwing Stick supplied in protective case

		*RRP
CAC608	Carbon R20 Throwing Stick inc. case	£84.99



RANGEMASTER® PLASTIC THROWING STICKS

- Designed for baiting up with boilies a mid-long range
- Constructed from lightweight, flexible plastic that is very robust
- CAD designed shape for maximum distance
- Non-slip rubber handle
- Available in 20mm and 26mm options

		*RRP
CAC672	Rangemaster 20 Throwing Stick	£15.99
CAC673	Rangemaster 26 Throwing Stick	£15.99



CAMO SQUARE BUCKETS

- Available in 5 litre, 10 litre and 17 litre
- Perfect for spod mixes, maggots and groundbaits
- Square design makes them much more barrow-friendly than a more conventional round bucket
- Easier to stack and also easier to store in your car
- Extra strong metal handle

		*RRP
CBT005	Camo Square Bucket 5L	£5.99
CBT006	Camo Square Bucket 10L	£7.99
CBT007	Camo Square Bucket 17L	£9.99



BAITING SPOON

- Super-strong yet lightweight spoon
- Perfect for baiting up with a variety of baits at close range including boilies and particles
- Supplied with screw on knurled aluminium handle that includes arm strap
- Also perfect for mixing up spod mixes and keep your hands clean!

		*RRP
CAC505	Baiting Spoon	£17.99



ROD BANDS

- Handy bands for securing two halves of rod together
- Bands simply wrap around rods and Velcro in place
- Also enables you to secure the lead in place when packing rods away with lead still attached so it doesn't swing around and damage rod blank

*RRP

CAC552 Rod & Lead Bands £5.99



TIP & BUTT PROTECTORS

- Neoprene protectors that tip and butt sections slot into for secure transportation
- Wider protector for butt grip, whilst narrower one goes at tip end
- Velcro fastening to secure protectors in place

*RRP

CAC553 Tip & Butt Protectors £8.49

BOLT BUBBLE FLOATS

- First ever bubble-style float designed for surface feeding carp
- Streamlined, weight-forward design aids casting distance and also increases resistance when a fish straightens hooklink
- Anti-spook transparent body and low profile
- Casting weight adjusted by filling float with water
- Designed to be used in-line
- Supplied with two anti-tangle sleeves
- Available in four sizes - Small, Medium, Large and X-Large



*RRP

CAC160	Bolt Bubble - Small	£8.49
CAC161	Bolt Bubble - Medium	£8.49
CAC162	Bolt Bubble - Large	£8.99
CAC163	Bolt Bubble - XL	£8.99



HALO® ZIG FLOAT KIT

- Perfect for deep lakes where conventional Zig Rigs are impractical
- Designed for use with leads of 3oz (85g) or heavier
- Ultra buoyant high impact plastic
- Supplied with interchangeable nose caps in red and black
- Kit includes float and lead boom with large eye ring swivel, buoyancy bead and lead link attachment

*RRP

CAC375 Halo Zig Float Kit £14.99

MINI HALO® ZIG FLOAT KIT

- Scaled down version of the standard Halo Zig Float Kit
- Ideal for smaller venues
- Interchangeable high visibility red and black nose cones
- Perfect for deep lakes where conventional Zig Rigs are impractical
- Ultra buoyant high impact plastic
- Kit includes float and lead boom with large eye ring swivel, buoyancy bead and lead link attachment
- Works with leads as light as 2oz

*RRP

CAC428 Mini Halo Zig Float Kit £13.99

EXOCET® CONTROLLER FLOATS

- Aerodynamic design ensures not only long distances can be achieved but also accuracy too
- Hooklink exits the float at an angle on the cast, almost like a helicopter rig, which helps to reduce chance of tangles
- Stubby shape designed to reduce diving on impact with water
- Features flat faces to increase the bolt effect when a carp straightens the hooklink, which helps to improve hooking
- Flat sides also enable you to 'mend' your main line on the surface without moving the float too much
- Removable body allows easy changing of controller sizes and also means you don't have the body banging against the rod blank when travelling to and from a venue
- Hi-viz cap easy to see at range
- Low-Viz semi-translucent body looks inconspicuous in water
- Supplied with Standard swivel and Kwik Change Swivel plus a Micro Anti Tangle Sleeve to go over either swivel
- Two sizes available - Medium and Large



*RRP

CAC614	Exocet Medium Controller Float	£5.49
CAC615	Exocet Large Controller Float	£5.49



RAPIDE™ LOAD PVA BAG SYSTEM

- Eliminates need for PVA tape to tie a solid PVA bag
- Use the unique tool to fill the PVA bag and then tie it too!
- Possible to tie a complete bag in less than 20 seconds!
- Two sizes of loading tool available – Large and Small
- Large tool works with three different sizes of PVA bag - these being 85mm x 140mm (perforated), 75mm x 175mm (solid) and 85mm x 220mm (solid)
- Small tool works with two sizes of bag - 55mm x 120mm and 60mm x 130mm both of which are perforated
- Supplied with loading tool, locking collar, 25 PVA bags (20 for 75mm x 175mm and 85mm x 220mm)
- Supplied in handy waterproof tube
- Refills available separately and are colour-coded to the two sizes of system (pink for small, blue for large)
- XT refills available for anglers that want a thicker bag with a longer melt time for deeper water and warm water conditions

		*RRP
CPV029	Rapide Load PVA Kit (inc 25x Small Bags/Tool)	£9.99
CPV030	Rapide Load PVA Kit (inc 25x Medium Bags/Tool)	£9.99
CPV031	Rapide Load PVA Kit (inc 25x Large Bags/Tool)	£9.99
CPV032	Rapide Load PVA Kit (inc 20x XL Bags/Tool)	£9.99
CPV033	Rapide Load PVA Kit (inc 20x XXL Bags/Tool)	£9.99



Colour coded refills available

XT Bags also available

CPV034	PVA Small Bag Refill x25	
CPV035	PVA Medium Bag Refill x25	
CPV036	PVA Large Bag Refill x25	
CPV037	PVA XL Bag Refill x20	
CPV038	PVA XXL Bag Refill x20	
CPV044	Rapide Bags XT x25 - 60mm x 130mm	
CPV045	Rapide Bags XT x25 - 85mm x 140mm	
CPV046	Rapide Bags XT x20 - 75mm x 175mm	



HIGH RISERS

- Biodegradable, fish-safe and totally water soluble foam nuggets
- Designed to give you perfect tangle-free presentation
- The foam keeps your rig suspended from the lakebed for a few seconds before it dissolves leaving your hooklength to sit perfectly over any debris
- Jumbo Refill Pack also available

		*RRP
CAC358	Risers Pop-up Foam	£4.49
CPV042	High Riser Jumbo Refill	£4.25

PVA STRIPS

- Designed for use with Chod/Heli Buffer Sleeve, Heli Buffer Sleeve and Angled Drop Off Run Rig Kit when wanting the lead to eject
- Small PVA strip threading into hole on sleeve and is cut down to size
- Melt time depends on water temperature
- 10 lengths supplied per packet



		*RRP
CPV047	Edges PVA Strips x 10pc	£3.75



PVA TAPE

- 20m x 10mm Heavy embossed PVA tape
- 10m x 5mm Fine clear PVA tape
- Perfect for creating PVA stringers or tying off solid PVA bags in the traditional way

		*RRP
CPV013	Heavy Tape Embossed	£4.25
CPV014	Clear Tape	£4.25



Fine Mesh Heavy Mesh

PVA - Fine or Heavy?

Fine Mesh dissolves quickly - even in cold water - and allows small feed items such as maggots, micro pellets or groundbaits to be used without risk of them falling out. Heavy Mesh has a slower dissolve time and is perfect for warmer or deeper water and is suitable for larger pellets, particles and boilies.

PVA MESH 6M REFILL

- Supplied with 6m on dispenser
- Available in Fine Narrow and Fine Wide
- Offers outstanding value for money



*RRP

CPV040	Narrow Refill 6m Fine	£4.25
CPV041	Wide Refill 6m Fine	£4.25



PVA MESH

Fox PVA is the very highest quality and is supplied on a 10m Funnel and Plunger System at a price for which many other tackle companies only offer 7m!

- Available on a Wide (35mm), Narrow (25mm) or Super Narrow (14mm) tube
- Both Fine and Heavy mesh available to suit varying conditions or bait size
- Tough, anti-ladder construction that resists damage and handling
- Variety of cost effective refill options with 10m and 25m refill spoons available for all sizes and a new 6m refill now available in Narrow Fine and Wide Fine



WIDE PVA MESH

- Wide (35mm) tube
- 10m lengths supplied per packet
- 10m and 25m refill spoons available

		*RRP
CPV001	Wide Funnel System 10m Heavy Mesh	£11.99
CPV005	Wide 10m Refill Spool Heavy Mesh	£9.99
CPV006	Wide 25m Refill Spool Heavy Mesh	£18.99
CPV002	Wide Funnel System 10m Fine Mesh	£10.99
CPV009	Wide 10m Refill Spool Fine Mesh	£9.99
CPV010	Wide 25m Refill Spool Fine Mesh	£18.99



NARROW PVA MESH

- Wide (35mm) tube
- 10m lengths supplied per packet
- 10m and 25m refill spoons available

		*RRP
CPV003	Narrow Funnel System 10m Heavy Mesh	£11.99
CPV007	Narrow 10m Refill Spool Heavy Mesh	£8.99
CPV008	Narrow 25m Refill Spool Heavy Mesh	£17.99
CPV004	Narrow Funnel System 10m Fine Mesh	£10.99
CPV011	Narrow 10m Refill Spool Fine Mesh	£8.99
CPV012	Narrow 25m Refill Spool Fine Mesh	£17.99



SUPER NARROW PVA MESH

- Wide (35mm) tube
- 10m lengths supplied per packet
- 10m and 25m refill spoons available

		*RRP
CPV015	Super Narrow System 10m Heavy Mesh	£12.99
CPV017	Super Narrow 10m Refill Spool Heavy Mesh	£9.99
CPV016	Super Narrow System 10m Fine Mesh	£11.99
CPV018	Super Narrow 10m Refill Spool Fine Mesh	£9.99



ARMA® MESH

Quite simply one of the biggest advancements in hookbait systems ever, Arma Mesh is available on 7m tubes with both Narrow (14mm) and Wide (22mm) diameter variants and both Fine and Heavy weaves are available.

- Tough hexagonal weave, similar in appearance to PVA, but it is made from nylon and DOES NOT DISSOLVE IN WATER!
- Perfect for creating alternative hookbaits
- Supplied on a loading tube with a plunger
- Perfect for really soft baits such as bread, meat, cheese, prawns and pastes
- Good for baits that are not Hair Rig friendly such as hemp, canned tuna, mini pellets, boilie crumb and liquidised bread
- Also perfect for protecting hookbaits from nuisance species (Heavy version perfect for venues where crayfish are a real menace)



Tuna

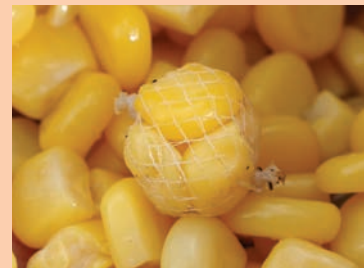

Sweetcorn



Pellet



Bread



WIDE ARMA® MESH

- Wide (22mm) tube
- 7m lengths supplied per packet
- 7m refill spools available

		*RRP
CPV022	Armamesh Wide Fine x 7m	£13.99
CPV026	Armamesh Wide Fine x 7m Refill	£10.99
CPV024	Armamesh Wide Heavy x 7m	£13.99
CPV028	Armamesh Wide Heavy x 7m Refill	£10.99



NARROW ARMA® MESH

- Narrow (14mm) tube
- 7m lengths supplied per packet
- 7m refill spools available

		*RRP
CPV021	Armamesh Narrow Fine x 7m	£12.99
CPV023	Armamesh Narrow Heavy x 7m	£12.99
CPV025	Armamesh Narrow Fine x 7m Refill	£9.99
CPV027	Armamesh Narrow Heavy x 7m Refill	£9.99





CLOTHING

With every year that passes the demand for carp fishing clothing increases and as a result so does the range that we offer! Once again this year we have lots of exciting new additions, not only to the Fox Chunk range but also the Black and Orange family and in fact a whole new range under the Green and Black banner. We also have additions to our footwear and sunglasses ranges, as well as a new two-piece winter suit that is sure to appeal to anglers on a tight budget that wish to stay warm through the coldest of conditions.

Over the coming pages you will find a real mixture of stylish items with highly technical items that are designed specifically to perform certain roles, such as keeping you warm or keeping you dry. Our team of clothing designers have worked extremely hard over the past 12 months to ensure that the offerings in our 2018 catalogue meet the tastes and requirements of as many anglers as possible, so whatever style you like to wear you are sure to find plenty of offerings to suit!

FOX® Chunk



Fold and Fix tongue for easy access



Hardwearing Vibram soles



Reinforced toe section



NEW

FOX® CHUNK CAMO FLIP FLOPS

- Fox Camo strap
- Neoprene lining on strap for added comfort
- Fox Camo print EVA footbed
- Durable rubber outer sole
- Tread on sole provides good grip
- Strap: 100% Polyester / Lining: 100% Neoprene, Footbed: 100% EVA, Outsole: 100% Rubber

*RRP

Sizes available: 7(41)-12(46)

£24.99

FOX® CHUNK EXPLORER HIGH BOOTS

- Hardwearing Vibram soles
- Hydro Guard waterproof fabric
- 3m Thinsulate insulation
- Comfortable fit
- Offers support to your ankles
- Reinforced toe section
- Reinforced rear kick plate for easy removal
- Fold and Fix tongues can be fixed down to make it very easy to slip the boot on when you get a bite
- Available in sizes: 7(41), 8(42), 9(43), 10(44), 11(45) and 12(46)

*RRP

Sizes available: 7(41)-12(46)

£74.99



FOX® CHUNK EXPLORER SHOES

- Hardwearing Vibram soles
- Hydro Guard waterproof fabric
- 3m Thinsulate insulation
- Comfortable fit
- Reinforced toe section
- Reinforced rear kick plate for easy removal
- Fold and Fix tongues can be fixed down to make it very easy to slip the shoe on when you get a bite
- Available in sizes: 7(41), 8(42), 9(43), 10(44), 11(45) and 12(46)

*RRP

Sizes available: 7(41)-12(46)

£69.99



FOX® CHUNK CAMO MID BOOTS

- Mixes style with functionality
- Hardwearing soles
- Waterproof fabric
- Features unique Fox Camo pattern
- Offers support to your ankles
- Comfortable fit
- Reinforced toe section
- Reinforced rear kick plate for easy removal
- Fold and Fix tongues can be fixed down to make it very easy to slip the boot on when you get a bite
- Available in sizes: 7(41), 8(42), 9(43), 10(44), 11(45) and 12(46)

*RRP

Sizes available: 7(41)-12(46)

£64.99



FOX® CHUNK CAMO TRAINERS

- Mixes style with functionality
- Hardwearing soles
- Waterproof fabric
- Features unique Fox Camo pattern
- Comfortable fit
- Reinforced toe section
- Reinforced rear kick plate for easy removal
- Fold and Fix tongues can be fixed down to make it very easy to slip the shoe on when you get a bite
- Available in sizes: 7(41), 8(42), 9(43), 10(44), 11(45) and 12(46)

*RRP

Sizes available: 7(41)-12(46)

£59.99



BLACK & ORANGE TRAINERS

NEW

- Following success of Fox Chunk Footwear launch we now have trainers to complement our top-selling Black & Orange clothing range
- Waterproof fabric
- Hardwearing soles
- Reinforced toe section
- Reinforced rear kick plate for easy removal
- Fold and fix tongues can be secured down to make it easy to slip them on when you get a bite
- Available in sizes: 7(41), 8(42), 9(43), 10(44), 11(45) and 12(46)



*RRP

Sizes available: 7(41)-12(46)

£59.99

BLACK & ORANGE CASUAL TRAINERS

NEW

- Lightweight casual lace up trainers
- Black cotton twill canvas upper with a PU water resistant coating
- Contrasting grey polyester lining
- Rubber sole
- Available in sizes: 7(41), 8(42), 9(43), 10(44), 11(45) and 12(46)



*RRP

Sizes available: 7(41)-12(46)

£39.99

FOX® CHUNK KHAKI/CAMO CASUAL TRAINERS

NEW

- Lightweight casual lace up trainers
- Khaki cotton twill canvas upper with a PU water resistant coating
- Fox Camo polyester lining
- Rubber sole
- Available in sizes: 7(41), 8(42), 9(43), 10(44), 11(45) and 12(46)



*RRP

Sizes available: 7(41)-12(46)

£39.99

FOX® CHUNK CAMO CLOGS

NEW

- One piece moulded top, footbed and sole
- Fox Camo print
- Waterproof and buoyant
- Lightweight
- Easy to clean and quick drying
- Heel strap for secure fit
- Easy to slip on and off
- Ventilation ports encourage water to drain away and air circulation
- 100% EVA
- Available in sizes: 7(41), 8(42), 9(43), 10(44), 11(45) and 12(46)



*RRP

Sizes available: 7(41)-12(46)

£15.99



NEW

CHEST WADERS

- 700g heavy-duty fabric
- Chunky soles for maximum grip
- Fox branded fully adjustable elasticated shoulder straps
- Adjustable Elasticated Chest
- Reinforced knee sections for added protection
- Perfect for anglers that need to enter the margins for landing fish, placing rigs, baiting up, catch pictures and returning fish safely

*RRP

Foot Sizes available: 7(41)-12(46)

£79.99



Chunky sole for maximum grip

FOX® Chunk



Dual layer system for optimum heat retention



Sherpa fleece lining for incredible warmth and comfort



Heavy-duty YKK zips throughout for top performance

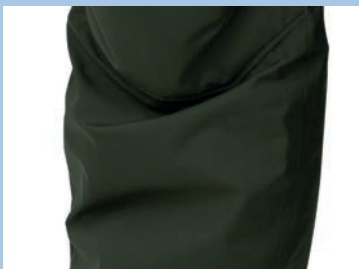

Padded knee section for extra protection



Adjustable Velcro ankle cuffs with waterproof YKK zips

FOX® CHUNK SHERPA-TEC JACKET

- Designed to offer ultimate protection from the elements
- Manufactured to the highest standards using cutting edge technology and fabrics
- Dual layer system that utilises waterproof laminated polyester fabric lined with thermo-performance Sherpa fleece
- Outer fabric is 100% polyester laminated with TPU (thermoplastic polyurethane)
- All internal seams are fully taped to prevent water ingress
- Hydrostatic Head of 5,000mm
- 3,000g/m² breathable
- Chunky, waterproof YKK front zip with internal anti-snap baffle
- Heavy-duty YKK zips throughout
- Removable hood with fully adjustable wired peak
- Double exit hem and waist draw cord
- Velcro adjustable outer cuffs
- 2 internal and 2 external zipped pockets
- Sizes available: S/M/L/XL/XXL/XXXL



*RRP

Sizes available: S/M/L/XL/XXL/XXXL

£119.99



FOX® CHUNK SHERPA-TEC SALOPETTES

- Designed to offer ultimate protection from the elements
- Manufactured to the highest standards using cutting edge technology and fabrics
- Dual layer system that utilises waterproof laminated polyester fabric lined with thermo-performance Sherpa fleece
- Outer fabric is 100% polyester laminated with TPU (thermoplastic polyurethane)
- All internal seams are fully taped to prevent water ingress
- 100% polyester laminated with TPU (thermoplastic polyurethane) with Thermo-performance Sherpa fleece lining
- Hydrostatic Head of 5,000mm
- 3,000g/m² breathable
- Chunky, waterproof YKK front zip with internal anti-snap baffle
- Heavy-duty YKK zips throughout
- Half leg waterproof YKK zips with internal storm guard
- Velcro adjustable ankle cuffs
- Part elasticated waist
- Padded pleated knees
- Adjustable branded shoulder straps
- Velcro fastening cargo pockets
- Thermo-performance hand warmer pockets
- Sizes available: S/M/L/XL/XXL/XXXL

*RRP

Sizes available: S/M/L/XL/XXL/XXXL

£114.99

FOX® CHUNK 10K HYDRO JACKET

- Our most advanced and technical waterproof clothing ever!
- 3/4 length jacket that uses a three layer construction
- DWR waterproof outer layer with a breathable hydro performance membrane mid layer
- All internal seams are fully taped to prevent water ingress
- 10,000mm Hydrostatic Head
- 3000g/m² breathable
- YKK waterproof front zip with internal storm flap and chin guard
- Waterproof YKK zips throughout
- Fully adjustable wired peak hood
- Brush lined integral collar
- Double exit hem drawcord
- Velcro adjustable outer cuffs
- Neoprene snug cuffs
- Lumbar drawcord
- Styled in unique Fox Camo pattern
- Sizes available: S/M/L/XL/XXL/XXXL



*RRP

Sizes available: S/M/L/XL/XXL/XXXL

£159.99

FOX® Chunk



Three layer construction to ensure market-leading performance



Adjustable Velcro cuffs help to keep water out

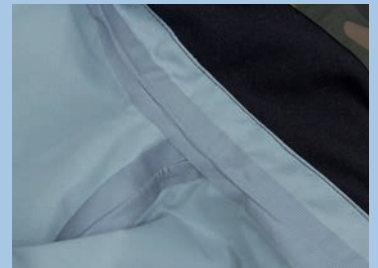

All internal seams are fully taped to prevent water penetration



Half leg waterproof YKK zips with Velcro storm guards



All internal seams are fully taped to prevent water ingress

FOX® CHUNK 10K HYDRO SALOPETTES

- Our most advanced and technical waterproof clothing ever!
- As with the Jacket these Salopettes also use a three layer construction
- DWR waterproof outer layer with a breathable hydro performance membrane mid layer
- All internal seams are fully taped to prevent water ingress
- 10,000mm Hydrostatic Head
- 3000g/m² breathable
- Three layer construction
- YKK waterproof front zip with internal storm flap
- Waterproof YKK zips throughout
- Khaki colour
- Velcro adjustable ankle cuffs
- Velcro fastening cargo pockets
- Half leg waterproof YKK zips with internal storm guard
- Tricot lined hand warmer pockets
- Part elasticated waist
- Padded pleated knees
- Adjustable branded shoulder straps
- Sizes available: S/M/L/XL/XXL/XXXL



*RRP

Sizes available: S/M/L/XL/XXL/XXXL

£134.99

FOX®
Chunk



Waterproof zips



Both items pack away into their own pockets for compact storage



Adjustable waist on trousers



Camo Softshell features drawstring hood and full length front zip



The Quilted Jacket benefits from a special blend of fibres that keep you warm and comfortable

FOX® CHUNK AQUOS RAIN SUIT

- Two-piece lightweight, waterproof suit comprising Jacket and Trousers
- Ideal for placing over the top of your clothes at any time of year to keep you dry
- Jacket and Trousers both have a 10,000mm Hydrostatic Head
- Jacket and Trousers both have a 3,000g/m² breathable
- Lightweight 3 layer construction on both garments
- Both items pack away into their own pocket for compact storage
- Roll away adjustable hood on jacket
- Waterproof zips on the jacket
- Half elasticated Velcro adjustable cuffs on jacket
- Jacket features double exit hem draw cord
- Outer layer on both items is 100% polyester
- Mid-layer on both items is 100% TPU (thermoplastic polyurethane)
- Inner mesh layer on both items is 100% polyester
- Zipped pockets on the trousers
- Half leg waterproof zips on the trousers
- Suit is available in: S/M/L/XL/XXL/XXXL



*RRP

Sizes available: S/M/L/XL/XXL/XXXL

£119.99

NEW

FOX® CHUNK CAMO SOFTSHELL HOODY

- Shower and wind resistant soft shell hoody styled in unique Fox Camo
- 8000mm hydro static head and 2000Ggsm/24hr breathable
- Drawstring hood
- Elasticated cuffs and waist
- External zipped chest pocket
- Pouch pockets
- Full length front zip
- Sizes available: S/M/L/XL/XXL/XXXL
- Outer: 96% Polyester, 4% Elastane, Lining: 100% Polyester

*RRP

Sizes available: S/M/L/XL/XXL/XXXL

£59.99



NEW

FOX® CHUNK OLIVE QUILTED JACKET

- Quilted lightweight hooded jacket
- Special blend of synthetic fibres give an insulated and comfortable filling
- PU water-resistant coated outer fabric
- Zipped hand pockets
- Full length zip baffle
- Internal pocket
- Sizes available: S/M/L/XL/XXL/XXXL
- Outer: 100% Nylon, Padding: 100% Polyester, Lining: 100% Nylon

*RRP

Sizes available: S/M/L/XL/XXL/XXXL

£49.99



FOX® CHUNK CAMO HOODY

- Feature unique Fox Camo pattern
- Fully lined with a soft, insulating tricot fabric
- Lined hand-warming kangaroo front pocket
- Elasticated cuffs
- Drawcords on hood
- Branded metal eyelets
- Soft brushed back fabric
- Main fabric: 80% cotton 20% polyester
Lining: 100% cotton
- Matching joggers available
- Sizes available: S/M/L/XL/XXL/XXXL

NEW



*RRP

Sizes available: S/M/L/XL/XXL/XXXL

£54.99

FOX® Chunk



The Camo Hoody features elasticated cuffs...



...plus drawcords on the hood



FOX® CHUNK RIBBED HOODY KHAKI

- Khaki colour with discreet Fox Chunk logo on chest
- Elasticated waist and cuffs
- Chunky drawstring on hood
- Front pocket
- Discreet badge on hem
- Comfortable fit
- Main fabric: 80% cotton, 20% polyester

*RRP

Sizes available: S/M/L/XL/XXL/XXXL

£44.99



FOX® CHUNK RIBBED HOODY BURGUNDY

- Burgundy colour with discreet Fox Chunk logo on chest
- Elasticated waist and cuffs
- Chunky drawstring on hood
- Front pocket
- Discreet badge on hem
- Comfortable fit
- Main fabric: 80% cotton, 20% polyester

*RRP

Sizes available: S/M/L/XL/XXL/XXXL

£44.99

FOX® CHUNK LIGHTWEIGHT ZIPPED HOODY KHAKI

- Shoulder and elbow patches
- Drawcord hood
- Elasticated cuffs and hem
- Subtle branding
- Main fabric: 50% cotton, 50% polyester

*RRP

Sizes available: S/M/L/XL/XXL/XXXL

£19.99



FOX® CHUNK CREW SWEATSHIRT

- Crew neck design
- Elasticated cuffs and hem
- Subtle branding
- Front pocket
- Main fabric: 80% cotton, 20% polyester

*RRP

Sizes available: S/M/L/XL/XXL/XXXL

£31.99

FOX®
Chunk



**FOX® CHUNK
BASE LAYER**

- Ideal base to wear beneath mid and outer layer garments offering great thermal protection
- Comprises of top and bottoms
- Perfect for sleeping in
- Quick drying and breathable material
- Moisture wicking performance
- Also doubles up as a lightweight outer garment
- Branded chest zip
- Main fabric: 100% polyester

*RRP

Sizes available: S/L/XL/XXL/XXXL £34.99

**FOX® CHUNK
LONG SLEEVE ZIPPED
TOP KHAKI/CAMO**

- Subtle branding
- Camo sleeves with khaki body
- Main fabric: 100% cotton

*RRP

Sizes available: S/M/L/XL/XXL/XXXL £19.99



FOX® CHUNK KHAKI POLO

- Made from top quality fabrics
- Khaki colour with small orange Fox Chunk logo on chest pocket
- Camo trim on chest pocket and hem
- Discreet badge on hem
- Comfortable fit
- Main fabric: 80% cotton, 20% polyester

*RRP

Sizes available: S £14.99



**FOX® CHUNK STONEWASH
MARL T-SHIRT OLIVE**

- Stylish design
- Main fabric: 60% cotton, 40% polyester

*RRP

Sizes available: S/M/L/XL/XXL/XXXL £16.99

**FOX® CHUNK
STONEWASH POLO KHAKI**

- Subtle branding
- Chest pocket
- Main fabric: 100% cotton

*RRP

Sizes available: S/M/L/XL/XXL/XXXL £19.99



**FOX® CHUNK STONEWASH
T-SHIRT KHAKI**

- Stylish design
- Main fabric: 100% cotton

*RRP

Sizes available: S/M/L/XL/XXL/XXXL £16.99



NEW

FOX® CHUNK CAMO JOGGERS

- Feature unique Fox Camo pattern
- Fully lined with a soft, insulating tricot fabric
- Zipped front pockets
- Elasticated ankles and waist
- Drawcord on waist
- Branded metal eyelets
- Soft brushed back fabric
- Main fabric: 80% cotton 20% polyester
Lining: 100% cotton
- Matching hoody available
- Sizes available: S/M/L/XL/XXL/XXXL

*RRP

Sizes available: S/M/L/XL/XXL/XXXL £44.99



FOX® CHUNK LIGHTWEIGHT JOGGERS KHAKI

- Drawcord waist
- Elasticated ankles
- Subtle branding
- Main fabric: 50% cotton, 50% polyester

*RRP

Sizes available: S/M/L/XL/XXL/XXXL £19.99



FOX® CHUNK RIBBED JOGGERS

- Lightweight joggers with 'skinny fit' design
- Available in Khaki or grey
- Discreet Fox Chunk logos
- Chunky drawstring on waist
- Ribbed styling on outer legs
- Two zipped front pockets
- Unzipped rear pocket
- Elasticated waist and ankles
- Comfortable fit
- Main fabric: 80% cotton, 20% polyester

*RRP

Sizes available: S/M/L/XL/XXL/XXXL £34.99



NEW

FOX® CHUNK KHAKI COMBAT TROUSERS

- Tailored fit with a semi-elasticated waist for added comfort
- Oil washed giving a softer feel fabric
- Waist features belt loops
- Utility pockets for storing essential items
- Sizes available: S/M/L/XL/XXL/XXXL
- Main fabric: 100% Cotton

*RRP

Sizes available: S/M/L/XL/XXL/XXXL £39.99



FOX® CHUNK LIGHTWEIGHT CARGO SHORTS

- Fox Camo pattern
- Lightweight cargo pant style
- Perfect for summer use
- Button, zip and belt loops on waist
- Two front pockets
- Two 'button up' side pockets
- Two rear pockets
- Main fabric: 100% cotton

*RRP

Sizes available: S/M/L/XL/XXL/XXXL £26.99



NEW

FOX® CHUNK CAMO JOGGER SHORTS

- Features unique Fox Camo pattern
- Elasticated, drawcord waist
- Main fabric: 80% Cotton, 20% Polyester
- Sizes available: S/M/L/XL/XXL/XXXL

*RRP

Sizes available: S/M/L/XL/XXL/XXXL £19.99



FOX
Chunk



BEANIE

Main fabric: 50% Acrylic, 50% Polyester

CPR759 Orange/Black Marl Beanie

CPR760 Grey/Black Marl Beanie

CPR761 Burgundy/Black Marl Beanie



BOBBLE HAT

Main fabric: 100% Acrylic

CPR763 Burgundy/Black Bobble

CPR762 Grey/Black Bobble



HEAVY KNIT HAT

Main fabric: 100% Acrylic

CPR764 Camo Heavy Knit Beanie



BUCKET HAT

Main fabric: 100% Cotton

CPR607 Khaki Bucket Hat



BUCKET HAT

Main fabric: 100% Cotton

CPR608 Camo Bucket Hat



PEAKED BEANIE

Main fabric: 100% Acrylic

CPR766 Grey Peaked Beanie



PEAKED BEANIE

Main fabric: 50% Acrylic, 50% Polyester

CPR767 Khaki Peaked Beanie



MESH BASEBALL CAP

Main fabric: 80% Cotton, 20% Polyester

CPR599 Camo Mesh Back



SOLID BASEBALL CAP

Main fabric: 60% Cotton, 40% Polyester

CPR600 Camo Solid Back



CORD BASEBALL CAP

Main fabric: 100% Cotton

CPR603 Khaki Cord



TWILL BASEBALL CAP

Main fabric: 100% Cotton

CPR604 Khaki Twill



BASEBALL CAP

Main fabric: 35% Acrylic, 60% Cotton, 5% Wool

CPR601 Grey/Burgandy/Orange



TWILL BASEBALL CAP

Main fabric: 85% Acrylic, 15% Wool

CPR602 Grey/Burgandy Twill

NEW

WINTER SUIT

- Top quality thermal insulation on both garments to keep you warm in the coldest months
- Jacket and salopettes both have PU coating with hydrostatic head of 5000mm
- Both jacket and salopettes are 3000gsm/24hr breathable
- Two-way main zip (with baffles) on both jacket and salopettes
- Jacket features micro fleece lining on pockets, collar and hood
- Hood on jacket is removable and also features high chin baffle with adjustable bungee cords
- Adjustable bungee cord hem on jacket
- Jacket also features internal zippered chest pocket, neoprene inner snug cuffs with thumb holes and Fox branding
- Salopettes feature Fox-branded elasticated shoulder straps with quick-release buckles as well as elasticated waist panels
- Micro fleece lining from knee upwards on salopettes, whilst the knee section is also pleated
- Salopettes have boot zips and adjustable ankle straps with Fox-branded rubber pull tabs
- Sizes available: S/M/L/XL/XXL/XXXL
- Outer – 100% Nylon
Thermal Insulation – 100% Polyester
Lining – 100% Polyester



Neoprene snug cuffs with Velcro fastening on Jacket to prevent draughts

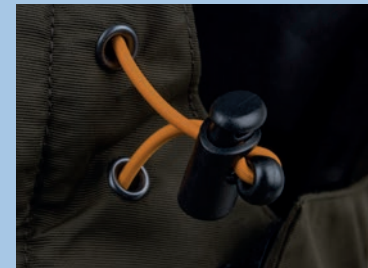

Adjustable bungee cords on Jacket hood to help keep the cold out



High collar with micro fleece lining, full length zip and baffles to maximise heat retention

*RRP

Sizes available: S/M/L/XL/XXL/XXXL

£149.99

**FOX®
Chunk**



CAMO SUNGLASSES

- Camo frame
- Polarized TAC Impact Resistant lens
- Brown lens
- UV400 Protection
- Supplied with hard case and cleaning cloth



KHAKI SUNGLASSES

- Khaki frame
- Polarized TAC Impact Resistant lens
- Grey lens
- UV400 protection
- Supplied with hard case and cleaning cloth



TORTOISE SHELL SUNGLASSES

- Tortoise shell frame
- Polarized TAC Impact Resistant lens
- Brown lens
- UV400 protection
- Supplied with hard case and cleaning cloth



FOX® SUNGLASSES

- Black frame with orange rubber inlay
- Polarized TAC Impact Resistant lens
- Grey lens
- UV400 Protection
- Supplied with hard case and cleaning cloth

*RRP

Camo Sunglasses	£19.99
Khaki Sunglasses	£19.99
Tortoise Shell Sunglasses	£19.99
Fox Sunglasses	£15.99



Drawcord hood and full length zip



Classic Fox black and orange styling

NEW

BLACK & ORANGE LIGHTWEIGHT ZIPPED HOODY

- Drawcord hood
- Elasticated cuffs and hem
- Orange Fox logo
- Main fabric: 50% cotton, 50% polyester
- Sizes available: S/M/L/XL/XXL/XXXL



*RRP

Sizes available: S/M/L/XL/XXL/XXXL

£22.99



BLACK & ORANGE SOFT SHELL JACKET

- Full length front zip
- Phone pocket
- Drawstring waist
- Zip pockets
- Elasticated and Velcro cuffs
- Drawstring hood
- Main fabric: 96% Polyester, 4% Elastane
Lining: 100% Polyester

*RRP

Sizes available: S/M/L/XL/XXL/XXXL

£69.99



BLACK & ORANGE SOFT SHELL HOODY

- Full length front zip
- Phone pocket
- Elasticated waist
- Elasticated cuffs
- Drawstring hood
- Main fabric: 96% Polyester, 4% Elastane
Lining: 100% Polyester

*RRP

Sizes available: S/M/L/XL/XXL/XXXL

£59.99



BLACK & ORANGE HEAVY LINED HOODY

- Internal lining for added warmth
- Easy slide zip
- Drawstring hood
- Elasticated waist
- Centre pocket
- Main fabric: 20% Polyester, 80% Cotton
Lining: 100% Polyester

*RRP

Sizes available: S/M/L/XL/XXL/XXXL

£49.99

NEW

BLACK & ORANGE LIGHTWEIGHT JOGGER SHORTS

- Drawcord waist
- Orange Fox logo
- Main fabric: 50% cotton, 50% polyester
- Sizes available: S/M/L/XL/XXL/XXXL



Drawcord waist for secure fit



Fox head logo on rubber decal

*RRP

Sizes available: S/M/L/XL/XXL/XXXL

£16.99



BLACK & ORANGE HOODY

- Drawstring hood
- Elasticated waist and cuffs
- Centre pocket
- Main fabric: 20% Polyester, 80% Cotton

*RRP

Sizes available: S/M/L/XL/XXL/XXXL

£39.99



BLACK & ORANGE POLO SHIRT

- Orange trim to sleeves
- Button up collar
- Fox logo on chest
- Main fabric; 20% Polyester, 80% Cotton

*RRP

Sizes available: S/M/L/XL/XXL/XXXL

£19.99



BLACK & ORANGE T-SHIRT

- Orange trim to sleeves
- Fox logo on chest
- Main fabric: 100% Cotton

*RRP

Sizes available: S/M/L/XL/XXL/XXXL

£17.99



Drawcord waist for secure fit



Rear pocket with Fox branding

NEW

BLACK & ORANGE LIGHTWEIGHT JOGGERS

- Drawcord waist
- Elasticated ankles
- Orange Fox logo
- Main fabric: 50% cotton, 50% polyester
- Sizes available: S/M/L/XL/XXL/XXXL

*RRP

Sizes available: S/M/L/XL/XXL/XXXL

£22.99



BLACK & ORANGE JOGGERS

- Internal lining for added warmth
- Elasticated waist with drawcord
- Zipped pockets
- Elasticated ankles
- Main fabric: 20% Polyester, 80% Cotton
Lining: 100% Polyester

*RRP

Sizes available: S/M/L/XL/XXL/XXXL

£37.99



BLACK & ORANGE HEAVY LINED JOGGERS

- Internal lining for added warmth
- Elasticated waist with drawcord
- Zipped pockets
- Elasticated ankles
- Main fabric: 20% Polyester, 80% Cotton
Lining: 100% Polyester

*RRP

Sizes available: S/M/L/XL/XXL/XXXL

£39.99

NEW

GREEN & BLACK JOGGERS

- Elasticated waist with drawcord
- Zipped pockets
- Elasticated ankles
- Main fabric: 20% Polyester, 80% Cotton
- Sizes available: S/M/L/XL/XXL/XXXL



Sizes available: S/M/L/XL/XXL/XXXL *RRP
£37.99



Zipped pockets



Elasticated ankles



NEW

GREEN & BLACK JOGGER SHORTS

- Main fabric: 50% Polyester, 50% Cotton
- Sizes available: S/M/L/XL/XXL/XXXL

Sizes available: S/M/L/XL/XXL/XXXL *RRP
£16.99



Jogger Shorts feature drawstring waist



NEW

GREEN & BLACK LIGHTWEIGHT CARGO SHORTS

- Main fabric: 100% Cotton
- Sizes available: S/M/L/XL/XXL/XXXL

Sizes available: S/M/L/XL/XXL/XXXL *RRP
£26.99



100% cotton fabric



Subtle Fox branding

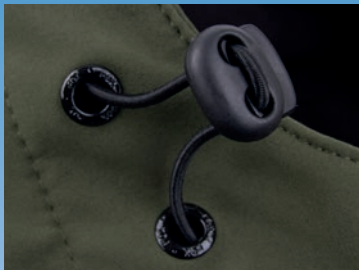

Elasticated drawstring hood



High collar with subtle branding



Phone pocket on chest

NEW

GREEN & BLACK SOFT SHELL JACKET

- Full length front zip
- Phone pocket
- Drawstring waist
- Zip pockets
- Elasticated and Velcro cuffs
- Drawstring hood
- Main fabric:
96% Polyester, 4% Elastane
Lining: 100% Polyester
- Sizes available:
S/M/L/XL/XXL/XXXL



*RRP

Sizes available: S/M/L/XL/XXL/XXXL

£69.99

NEW



GREEN & BLACK HOODY

- Drawstring hood
- Elasticated waist and cuffs
- Centre pocket
- Main fabric: 20% Polyester, 80% Cotton
- Sizes available: S/M/L/XL/XXL/XXXL

*RRP

Sizes available: S/M/L/XL/XXL/XXXL

£39.99

NEW



GREEN & BLACK HEAVY LINED HOODY

- Internal lining for added warmth
- Easy slide zip
- Drawstring hood
- Elasticated waist
- Centre pocket
- Main fabric: 20% Polyester, 80% Cotton
Lining: 100% Polyester
- Sizes available: S/M/L/XL/XXL/XXXL

*RRP

Sizes available: S/M/L/XL/XXL/XXXL

£49.99

NEW



GREEN & BLACK T-SHIRT

- Black trim to sleeves
- Fox logo on chest
- Main fabric: 100% Cotton
- Sizes available: S/M/L/XL/XXL/XXXL

*RRP

Sizes available: S/M/L/XL/XXL/XXXL

£17.99



FOX 

UK Headquarters

1 Myrtle Road, Brentwood, Essex, CM14 5EG.

European Distribution Centre

Transportzone Meer, Riyadhstraat 39,
2321 Meer, Belgium.

Fox International reserve the right to modify or alter prices or specifications in any respect without prior notice.

Technical data and specification correct at time of going to press.
All weights and dimensions are approximate.

E. & O.E. Copyright reserved. 

Acknowledgements

Live Photography:
Lewis Porter, Mauro Pitorri, Benjamin Versemann,
Stefan Fiedel, Hugo Van Gelder, Marian Sura,
Andreas Sherf, Harry Charrington

Translations by:

French: Stefan Hanff
Dutch: Mark Noorman,
Roelof Schut
German: Bastian Reetz
Italian: Daniele Pellacani
Polish: Cezary Karolczak

Hungarian: Csaba Balasi
Czech: Jakub Prudík,
Roman Vesely
Russian: Alexander Ostapenko,
Vladislav Vershinin
Romanian: Andrei Popescu,
Robert Nicolae

Special thanks to: Chris De Clercq, Scott Day, Shaun McSpadden,
Peter Simonic, Jaroslav Tesinsky, Mark Pitchers, Mark Brewster



JOIN TODAY!

Would you like access to a whole host of exclusive content and benefits including access to a members-only area of our website and entry to exclusive competitions?

If the answer is yes then make sure you sign up for **The Syndicate** today - it's totally FREE!

Visit www.foxint.com for more details.

Currently only available in English, German, Dutch and French languages.



DOWNLOAD FREE TODAY!

Swim Mapper is designed to help you fish more accurately and effectively than ever before!

It was the world's first App that was specifically designed to aid anglers when mapping out and logging the details of each swim they fish on any given lake, river or canal. Using a series of photos and icons, **Swim Mapper** allows you to record specific visual marks and concise distances to ensure you can arrive back into a swim you've previously 'mapped' and be angling with pinpoint accuracy within minutes.

To find out more about **Swim Mapper** visit www.swimmapper.com

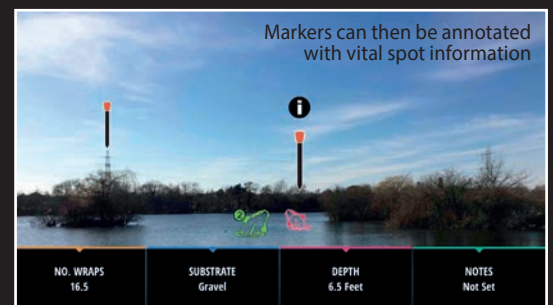
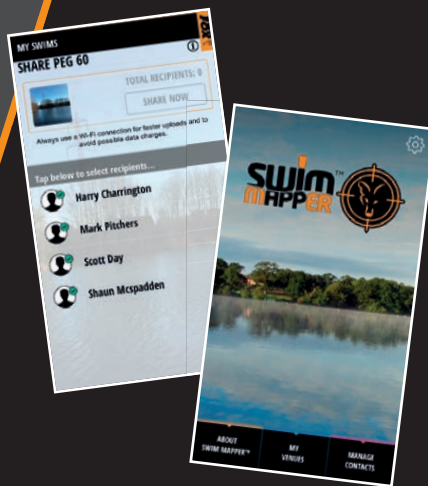

Markers can then be annotated with vital spot information



UK - AAA409



FILLED WITH NEW PRODUCTS INSIDE!